

SIEMENS



RVP340

Heating controller for 1 heating circuit

RVP350 and RVP351

**Heating controllers for 1 heating circuit and d.h.w.
Basic Documentation**

Siemens Switzerland Ltd
Industry Sector
Building Technologies Division
Theilerstrasse 1a
CH 6300 Zug
Tel. +41 58 724 24 24
www.siemens.com/sbt

© 2011 Siemens Switzerland Ltd
Subject to change

Contents

1	Summary	9
1.1	Brief description and key features.....	9
1.2	Type summary.....	9
1.3	Equipment combinations.....	9
1.3.1	Suitable sensors.....	9
1.3.2	Suitable room units	10
1.3.3	Suitable actuators	10
1.3.4	Communication	10
1.3.5	Documentation	10
2	Use	11
2.1	Types of plant.....	11
2.2	Types of houses and buildings.....	11
2.3	Types of heating systems	11
2.4	Heating circuit functions	11
2.5	D.h.w. functions.....	12
3	Basics	13
3.1	Key technical features.....	13
3.2	Plant types	13
3.2.1	Plant types with regard to heating circuit.....	13
3.2.2	Plant types with regard to d.h.w.	14
3.2.3	Selectable combinations	14
3.3	Setting levels, function blocks, and plant types	15
3.4	Heating circuit operating modes	16
3.5	D.h.w. heating modes	17
3.6	Manual control.....	17
3.7	Plant type and operating mode	18
3.8	Operating state and operating level	18
4	Acquisition of measured values	19
4.1	Room temperature (A6, B5)	19
4.1.1	Types of sensors	19
4.1.2	Error handling.....	19
4.1.3	Room model.....	19
4.2	Flow temperature (B1)	20
4.2.1	Types of sensors	20
4.2.2	Error handling.....	20
4.3	Boiler temperature (B2).....	20
4.3.1	Types of sensors	20
4.3.2	Error handling.....	20
4.4	Outside temperature (B9)	20
4.4.1	Types of sensors	20
4.4.2	Error handling.....	20
4.5	Return temperature (B7)	21
4.5.1	Types of sensors	21
4.5.2	Error handling.....	21
4.6	Storage tank temperature (B31, B32)	21
4.6.1	Types of sensors	21

4.6.2	Error handling	21
4.7	Collector temperature (B6)	22
4.7.1	Type of sensor	22
4.7.2	Error handling	22
5	Function block: End-user space heating	23
5.1	Operating lines	23
5.2	Setpoints	23
5.2.1	General	23
5.2.2	Frost protection for the building	23
5.3	Heating program	24
5.4	Holiday program	24
5.5	Heating curve	24
6	Function block: End-user d.h.w.	25
6.1	Operating lines	25
6.2	Setpoints	25
6.2.1	NORMAL d.h.w. temperature setpoint	25
6.2.2	REDUCED d.h.w. temperature setpoint	25
6.3	Actual value	26
7	Function block: End-user general	27
7.1	Operating lines	27
7.2	Scheduler program 2	27
7.3	Time of day and date	27
7.4	Faults	28
8	Function block: Plant configuration	29
8.1	Operating line	29
8.2	General	29
9	Function block: Space heating	30
9.1	Operating lines	30
9.2	Automatic ECO function	30
9.2.1	Compensating and auxiliary variables	30
9.2.2	Heating limits	31
9.2.3	Mode of operation	31
9.3	Room temperature source	32
9.4	Optimization	33
9.4.1	Definition and purpose	33
9.4.2	Basics	33
9.4.3	Optimization with room sensor	33
9.4.4	Optimization without room sensor	33
9.4.5	Process	34
9.4.6	Room model temperature	34
9.4.7	Optimized switching off	35
9.4.8	Quick setback	35
9.4.9	Optimized switching on	36
9.4.10	Boost heating	36
9.5	Room functions	37
9.5.1	Maximum limitation of room temperature	37
9.5.2	Room influence	38
9.6	Heating curve	38

9.6.1	Purpose	38
9.6.2	Settings	38
9.6.3	Deflection	39
9.6.4	Parallel displacement of heating curve	40
9.7	Generation of setpoint.....	41
9.7.1	Weather-compensated control.....	41
10	Function block: Actuator heating circuit	42
10.1	Operating lines	42
10.2	Limitations	42
10.2.1	Flow temperature limitations	42
10.2.2	Setpoint increase	43
10.3	Type of actuator	43
10.3.1	2-position control.....	43
10.3.2	3-position control.....	44
10.4	Auxiliary variables in interconnected plants.....	44
10.4.1	Temperature boost mixing valve/heat exchanger	44
10.5	Pulse lock with 3-position actuator.....	44
11	Function block: Boiler	45
11.1	Operating lines.....	45
11.2	Operating mode	45
11.3	Limitations	46
11.3.1	Maximum limitation of boiler temperature	46
11.3.2	Minimum limitation of boiler temperature	46
11.3.3	Actions during d.h.w. heating	46
11.4	2-position control.....	46
11.4.1	Control with 1-stage burner.....	46
11.4.2	Control with 2-stage burner.....	47
11.4.3	Frost protection for the boiler	48
11.4.4	Protective boiler startup	49
11.4.5	Protection against boiler overtemperatures	49
11.5	Operating mode of pump M1	50
12	Function block: Setpoint return temperature limitation	51
12.1	Operating line.....	51
12.2	Description	51
12.3	Minimum limitation of return temperature	51
12.3.1	Type of sensor.....	51
12.3.2	Mode of operation	52
12.3.3	Mode of operation with an autonomous unit (without bus).....	53
12.3.4	Mode of operation in interconnected plants.....	53
13	Function block: District heat	54
13.1	Operating lines.....	54
13.2	Limitations	54
13.2.1	Maximum limitation of primary return temperature	54
14	Function block: D.h.w.	56
14.1	Operating lines.....	56
14.2	Assignment of d.h.w. heating	56
14.3	Program for the circulating pump.....	56
14.4	Frost protection for d.h.w.	56

14.5	Release of d.h.w. heating.....	57
14.5.1	Function.....	57
14.5.2	Release programs.....	57
14.5.3	D.h.w. heating during holiday periods.....	58
14.6	Priority and flow temperature setpoint.....	58
14.6.1	Settings.....	58
14.6.2	D.h.w. priority.....	58
14.6.3	Absolute priority.....	59
14.6.4	Shifting priority.....	59
14.6.5	No priority.....	59
14.6.6	Flow temperature setpoint.....	60
14.6.7	Maximum selection.....	60
14.6.8	D.h.w.	60
14.7	Type of d.h.w. charging.....	60
14.8	D.h.w. storage tank sensor/thermostat.....	60
14.9	Boost of d.h.w. charging temperature.....	62
14.10	Maximum d.h.w. charging time.....	62
14.11	Setpoint for legionella function.....	63
14.12	Forced charging.....	63
14.13	Protection against discharging.....	63
14.13.1	Purpose.....	63
14.13.2	Mode of operation.....	63
14.14	Manual d.h.w. charging.....	64
15	Function block: Multifunctional relays.....	65
15.1	Operating lines.....	65
15.2	Functions of multifunctional relays K6/K7.....	65
15.2.1	No function.....	66
15.2.2	Relay energized in the event of fault.....	66
15.2.3	Relay energized when there is heat demand.....	66
15.2.4	Circulating pump.....	66
15.2.5	Collector pump.....	67
15.2.6	Type of d.h.w. charging.....	67
16	Function block: Legionella function.....	69
16.1	Operating lines.....	69
16.1.1	Setpoint/switching on/off.....	69
16.1.2	Periodicity of legionella function.....	69
16.1.3	Starting point.....	69
16.1.4	Dwelling time at legionella setpoint.....	69
16.1.5	Operation of circulating pump.....	70
16.2	Mode of operation.....	70
17	Function block: Service functions and general settings.....	72
17.1	Operating lines.....	72
17.2	Display functions.....	72
17.2.1	Hours run counter.....	72
17.2.2	Software version.....	72
17.3	Commissioning aids.....	73
17.3.1	Simulation of outside temperature.....	73
17.3.2	Relay test.....	73
17.3.3	Sensor test.....	74
17.4	Auxiliary functions.....	75

17.4.1	Frost protection for the plant	75
17.4.2	Manual overriding of operating mode (contact H1).....	76
17.4.3	Pump overrun.....	76
17.4.4	Pump kick.....	77
17.4.5	Winter-/summertime changeover.....	77
17.4.6	Locking signal gain	77
17.5	Inputs for LPB (RVP340 and RVP350).....	79
17.5.1	Source of time of day	79
17.5.2	Outside temperature source	80
17.5.3	Addressing the devices.....	80
17.5.4	Bus power supply.....	81
17.5.5	Bus loading number	81
18	Function block: Solar d.h.w.	82
18.1	Operating lines	82
18.2	General	82
18.3	Functions.....	83
18.3.1	Temperature differential ON/OFF solar.....	83
18.3.2	Minimum charging temperature	83
18.3.3	Minimum running time.....	84
18.3.4	Frost protection temperature for the collector	84
18.3.5	Overtemperature protection for the collector	85
18.3.6	Storage tank recooling	86
18.3.7	Evaporation temperature of heat conducting medium.....	87
18.3.8	Maximum limitation of charging temperature	87
18.3.9	Maximum limitation of storage tank temperature.....	88
18.3.10	Collector start function	88
19	Function block: Locking functions	89
19.1	Operating line.....	89
19.2	Locking settings on the software side	89
20	Communication	90
20.1	Interplay with room units	90
20.1.1	General	90
20.1.2	Interplay with room unit QAA50.110/101	90
20.1.3	Interplay with room unit QAW70	91
20.1.4	Interplay with SYNERGYR central unit OZW30	93
20.2	Communication with other devices	93
21	Handling	94
21.1	Operation	94
21.1.1	General	94
21.1.2	Operating elements.....	95
21.1.3	Setting levels and access rights.....	97
21.2	Commissioning.....	98
21.2.1	Installation Instructions	98
21.2.2	Operating lines.....	98
21.3	Installation	99
21.3.1	Mounting location	99
21.3.2	Mounting choices	99
21.3.3	Electrical installation.....	99
22	Engineering	100
22.1	Connection terminals	100

22.2	Connection diagrams	101
22.2.1	Low-voltage side	101
22.2.2	Mains voltage side	101
23	Mechanical design	103
23.1	Basic design	103
23.2	Dimensions.....	103
24	Addendum.....	104
24.1	Technical data	104
24.2	Revision history.....	104

1 Summary

1.1 Brief description and key features

- RVP340, RVP350 and RVP351 are multifunctional heating controllers for use in residential and nonresidential buildings
- They are suited for weather-compensated flow temperature control of 1 heating zone with or without room temperature influence and for demand-dependent boiler temperature control (RVP350 and RVP351)
- The controllers are used in plants with own heat generation (RVP350 and RVP351) or district heat connection (RVP340)
- On the d.h.w. side, the RVP350 and RVP351 controllers cover plants with storage tank charging via the heating system, with electric immersion heater, and with solar collectors
- The RVP340 controller is supplied with 2 programmed plant types, the RVP350 and RVP351 with 3. When a certain type of plant is selected, all functions and settings required for the particular plant will be activated
- Multifunctional relays provide additional control functions, if required
- Heating curve adjustment is digital. Readjustments of the room temperature are made with a knob
- All other parameter settings are made based on the operating line principle.
- The RVP340 and RVP350 controllers are capable of communicating with other LPB-compatible devices in the system via LPB (Local Process Bus). The RVP351 is a noncommunicating controller
- Key design features: Operating voltage AC 230 V, CE conformity, overall dimensions to IEC 61554 (144 x 96 mm)

1.2 Type summary

All types are compact controllers and require no plug-in modules. The controllers are supplied complete with base.

Product no.	Description
RVP340	Heating controller, communicating
RVP350	Heating controller for 1 heating circuit and d.h.w. heating with solar support, communicating
RVP351	Heating controller for 1 heating circuit and d.h.w. heating with solar support, noncommunicating

1.3 Equipment combinations

1.3.1 Suitable sensors

- For water temperatures:
Suitable are sensors operating with a sensing element LG-Ni1000:
 - Strapon sensor QAD22
 - Immersion sensors QAE22..
 - Immersion sensor QAP21.3 complete with connecting cable
 - Immersion sensor QAP21.2 complete with connecting cable (solar)

- For the room temperature:
Suitable are sensors operating with a sensing element LG-Ni1000:
 - Room sensor QAA24
- For the outside temperature:
 - Outside sensor QAC22 (sensing element LG-Ni1000)
 - Outside sensor QAC32 (sensing element NTC 575)

The controllers identify automatically the type of sensor used.

1.3.2 Suitable room units

- Room unit QAA50.110/101
- Room unit QAW70

1.3.3 Suitable actuators

The following types of actuators from Siemens can be used:

- Electromotoric or electrohydraulic 3-position actuators with a running time of 30...873 seconds
- 2-position actuators
- Operating voltage AC 24...230 V

1.3.4 Communication

The RVP340 and RVP350 controllers are capable of communicating with ...

- all types of LPB-compatible controllers supplied by Siemens,
- the SYNERGYR central unit OZW30 (software version 3.0 or higher).

The RVP351 controller cannot communicate via LPB.

1.3.5 Documentation

<i>Type of document</i>	<i>Document no.</i>	<i>Order no.</i>
Data Sheet RVP340, RVP350, RVP351	N2545	STEP Web Client
Installation Instructions RVP340, RVP350, RVP351 (de, en, fr, it, nl, es, el, and ru)	G2545	74 319 0815 0
Operating Instructions RVP340, RVP350, RVP351 (de, en, fr, it, nl, es, el, and ru)	B2545	74 319 0816 0
CE Declaration of Conformity	T2545	STEP Web Client
Environmental Declaration	E2545	STEP Web Client
LPB Basic System Data	N2030	STEP Web Client
LPB Basic Engineering Data	N2032	STEP Web Client

2 Use

2.1 Types of plant

The RVP3.. controllers are suitable for all types of heating plant that use weather-compensated flow temperature control.

With regard to d.h.w. heating, the controllers are suited for plants with storage tank charging.

Main applications:

- Heating zones and d.h.w. heating with own heat generation
- Heating zones with district heat connection
- Interconnected plants consisting of heat generation, several heating zones and central or decentral d.h.w. heating

2.2 Types of houses and buildings

Basically, the RVP3... controllers are suited for use in all types of houses and buildings. But they have been designed specifically for ...

- multifamily houses,
- single-family houses,
- small to medium-size nonresidential buildings.

2.3 Types of heating systems

The RVP3... controllers are used in connection with all standard heating systems, such as ...

- radiators,
- convectors,
- floor heating systems,
- ceiling heating systems,
- radiant panels.

2.4 Heating circuit functions

The RVP3... controllers are used if one or several of the following functions is/are required:

- Weather-compensated flow temperature control
- Flow temperature control via a modulating valve (3- or 2-position actuator)
- Weather-compensated flow temperature control and simultaneous demand-dependent control of the boiler temperature
- Optimization of switching on/off times according to the 7-day program entered
- Quick setback and boost heating according to the 7-day program entered
- Automatic ECO function: Demand-dependent switching of the heating system depending on the type of building structure and the outside temperature
- Multifunctional relays
- 7-day program for building occupancy with a maximum of 3 setback periods per day and daily varying occupancy schedules
- Input of 1 holiday period per year
- Automatic summer-/wintertime changeover
- Display of parameters, actual values, operating states and error messages
- Communication with other devices via LPB (only RVP340 and RVP350)

- Remote control via room unit and external contacts
- Service functions
- Frost protection for plant, the boiler and the house or building
- Minimum or maximum limitation of return temperature
- Minimum and maximum limitation of flow temperature
- Maximum limitation of room temperature
- Periodic pump run
- Pump overrun
- Maximum limitation of the rate of setpoint increase

For the programmed heating and d.h.w. circuits and their possible combinations, refer to chapter 3.2 "Plant types".

2.5 D.h.w. functions

The RVP35.. controllers are used if one or several of the following d.h.w. functions is/are required:

- D.h.w. storage tank charging through control of a charging pump, with or without circulating pump
- D.h.w. storage tank charging via solar collectors
- D.h.w. storage tank charging via electric immersion heater
- Own 7-day scheduler program for the release of d.h.w. charging
- Legionella function
- Selectable priority for d.h.w. heating: Absolute, shifting or parallel
- Manual d.h.w. charging
- Forced d.h.w. charging
- Frost protection for d.h.w.

3 Basics

3.1 Key technical features

The RVP3... line of heating controllers offer the following key technical features:

- The RVP340 controller is supplied with 2 programmed plant types, the RVP350 and RVP351 with 3. Illustrations of the different plant types are contained in chapter 3.2 "Plant types"
- The different functions are assigned to the setting levels "End-user", "Heating engineer" and "Locking level". The functions are grouped in the form of function blocks
- The settings are made via operating lines (see chapter 5 ff.)

Setting level	Function block
End-user	Space heating
	D.h.w.
	General
Heating engineer	Plant configuration
	Space heating
	Actuator heating circuit
	Boiler
	Return temperature limitation
	District heat
	D.h.w.
	Multifunctional relays
	Legionella function
	Service functions and general settings
	Solar d.h.w.
Locking level	Locking functions

3.2 Plant types

When commissioning a plant, the respective plant type must be entered. The required functions, settings and displays are then automatically assigned, and parameters that are not required will be hidden.

Plant types are usually made up of a heating circuit and a d.h.w. circuit.

Optional functions necessitate extra configurations.

Note

3.2.1 Plant types with regard to heating circuit

In terms of heating circuit, the following plant types are available:

- Heating circuit plant type 1: Space heating with mixing valve
- Heating circuit plant type 2: Space heating with district heat
- Heating circuit plant type 3: Space heating with mixing valve and precontrol with boiler

3.2.2 Plant types with regard to d.h.w.

In terms of d.h.w., the following plant types are available:

- D.h.w. plant type 0: No d.h.w.
- D.h.w. plant type 1: Storage tank with charging pump

Note

With d.h.w. plant type 1 (storage tank with charging pump), either the electric immersion heater or the solar collectors can be activated for d.h.w. charging.

3.2.3 Selectable combinations

Type	Type of heating circuit	Type of d.h.w. heating	RVP340	RVP350	RVP351*
1-0	Space heating with mixing valve	No d.h.w.	•		
1-1	Space heating with mixing valve	Storage tank with charging pump		•	•
2-0	Space heating with district heat	No d.h.w.	•		
3-0	Space heating with mixing valve and precontrol with boiler	No d.h.w.		•	•
3-1	Space heating with mixing valve and precontrol with boiler	Storage tank with charging pump		•	•

* In terms of functions, RVP350 and 351 are identical. The only difference is that RVP351 has no communication capability via LPB

Plant types

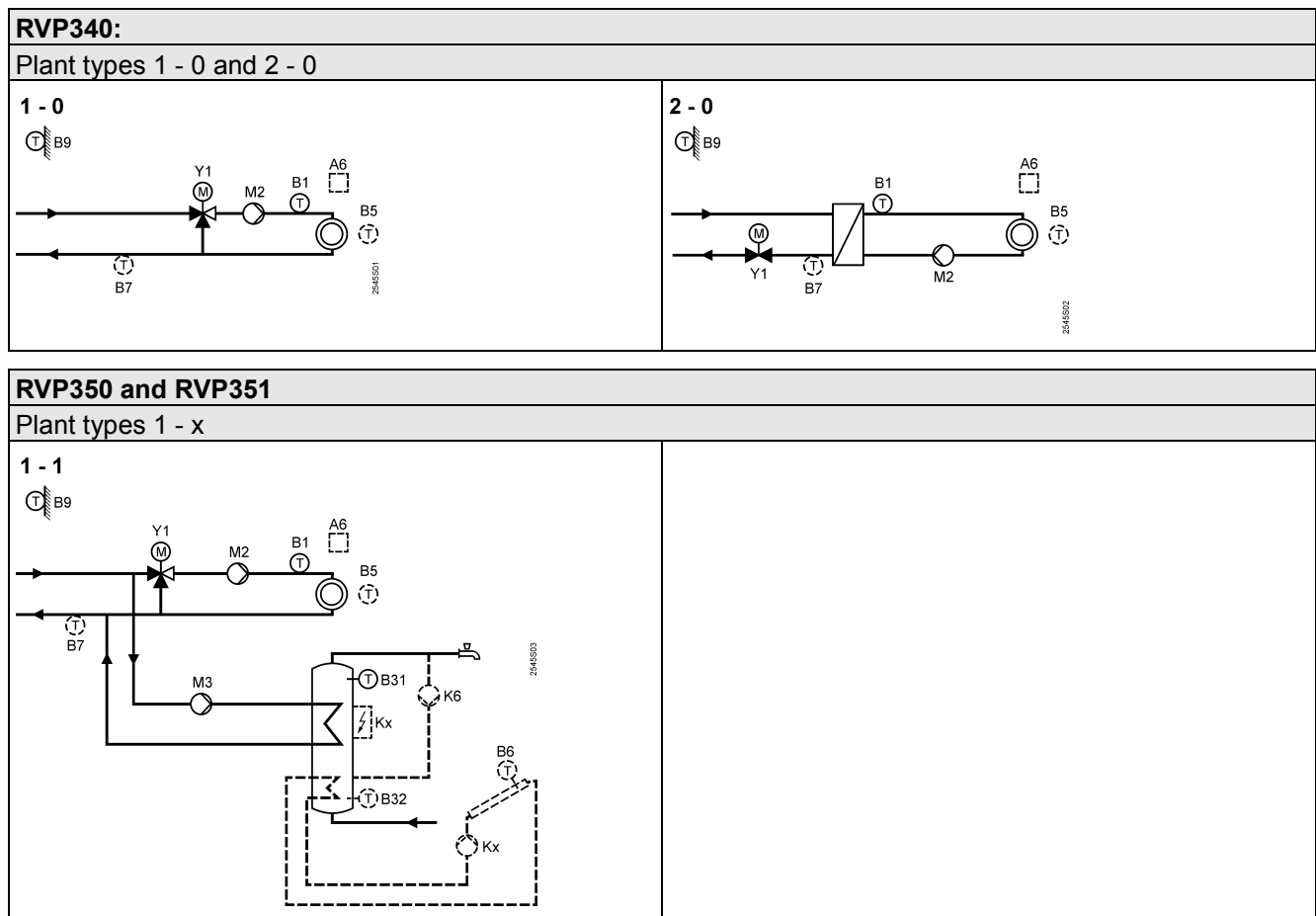

Plant types 3 - x

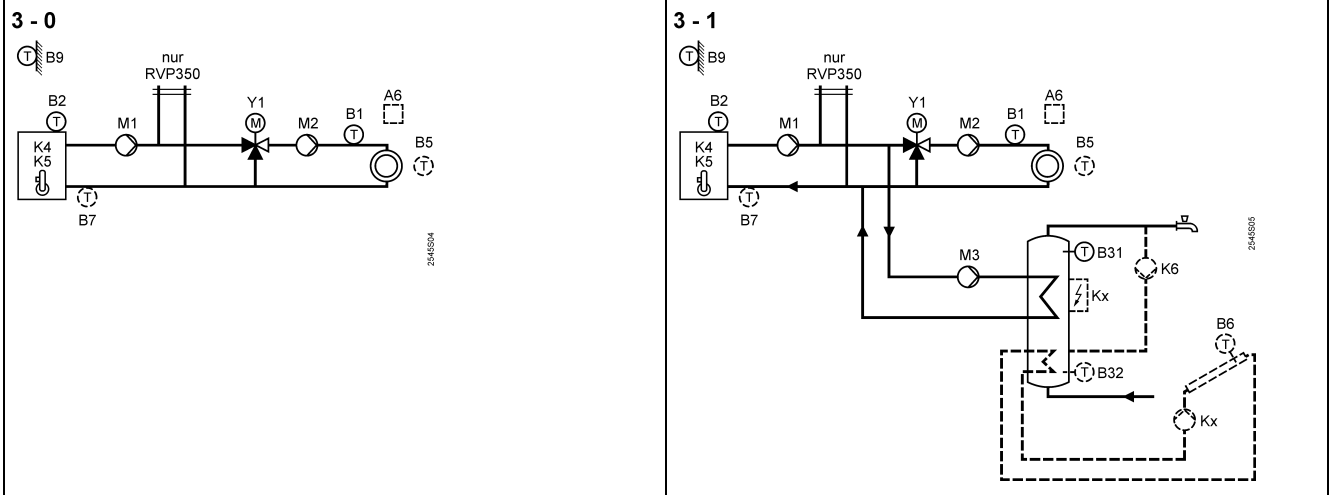

Components shown in broken lines are optional.

Key to plant components

A6	Room unit	Kx	K6, K7 = multifunctional outputs
B1	Flow sensor	K4	Burner stage 1
B2	Boiler sensor	K5	Burner stage 2
B31	D.h.w. storage tank sensor/thermostat	K6	Circulating pump
B32	D.h.w. storage tank sensor/thermostat	M1	Circulating pump
B5	Room sensor	M2	Heating circuit pump
B6	Collector sensor	M3	Storage tank charging pump
B7	Return sensor	N1	Controller RVP3..
B9	Outside sensor	Y1	Actuator heating circuit

3.3 Setting levels, function blocks, and plant types

Op. level	Function block	Plant type				
		1-0	1-1	2-0	3-0	3-1
End-user	End-user space heating	●	●	●	●	●
	End-user d.h.w.		●			●
	End-user general	●	●	●	●	●
Heating engineer	Plant configuration	●	●	●	●	●
	Space heating	●	●	●	●	●
	Actuator heating circuit	●	●	●	●	●
	Boiler				●	●
	Limitation of return temperature	●	●	●	●	●
	District heat			●		
	D.h.w.		●			●
	Multifunctional relays	●	●	●	●	●
	Legionella function		●			●
	Service functions and general settings	●	●	●	●	●
	Solar d.h.w.		●			●
Locking level	Locking functions	●	●	●	●	●

The above table shows ...

- which function blocks are assigned to the 3 operating levels,
- which function blocks are activated with the different plant types.

3.4 Heating circuit operating modes

The required operating mode is selected on the controller by pressing the respective button. The operating mode can also be changed by bridging terminals H1-M.



Automatic operation

- Automatic switching over from NORMAL to REDUCED temperature, and vice versa, according to the 7-day program entered
- Automatic switching over to holiday mode, and back, according to the holiday schedule entered
- Demand-dependent switching of the heating system according to the progression of room and outside temperature while giving consideration to the building's thermal inertia (automatic ECO function)
- Optional remote control via room unit
- Frost protection is ensured



Reduced operation

- Continuous heating to the REDUCED temperature
- With automatic ECO function
- No holiday mode
- Remote control via room unit not possible
- Frost protection is ensured



Normal operation

- Continuous heating to NORMAL temperature
- No automatic ECO function
- No holiday mode
- Remote control via room unit not possible
- Frost protection is ensured





Protection mode

- Heating is off, but is ready to operate
- Frost protection is ensured

3.5 D.h.w. heating modes



D.h.w. heating is switched on and off by pressing the respective button:

- ON (button  is lit): D.h.w. heating takes place independent of the heating circuit's operating mode and control. D.h.w. can be heated in one of 3 different ways:
 - According to the scheduler program 2 entered
 - According to the heating circuit program entered (–1 hour)
 - Continuously (24 hours a day)During the holiday period entered, d.h.w. heating and the circulating pump are deactivated when using controllers without bus connection (RVP351) (with data bus, depending on the setting made).
- OFF (button  dark): No d.h.w. heating. Frost protection is ensured
- Solar d.h.w. heating is always released, independent of the d.h.w. heating mode

3.6 Manual control



RVP3.. controllers can be switched to manual control. In that case, automatic control is deactivated.







During manual control, the various actuating devices behave as follows:

- Heating circuit mixing valve/2-port valve: Dead, but valve can be controlled manually with the buttons for manual control  (▼ and ▲):
 - 3-position actuators: Can be driven to any position by pressing ▼ (close) and ▲ (open).
 - 2-position actuators: Power supply to the actuator can be switched on by pressing ▼ and off by pressing ▲
- Heating circuit pump M2 runs continuously
- Boiler: The 2 burner stages are continuously on. Circulating pump M1 runs continuously
- Storage tank charging pump M3: Runs continuously
- Collector pump: Runs continuously
- Circulating pump K6: Runs continuously
- Electric immersion heater: Continuously released

Manual control also negates any overriding of the controller's operating mode (bridging of H1–M).

3.7 Plant type and operating mode

The following operating modes are available, depending on the selected type of plant:

Plant type	Auto 					
1-0, 2-0, 3-0	Yes	Yes	Yes	Yes	No	Yes
1-1, 3-1	Yes	Yes	Yes	Yes	Yes	Yes

3.8 Operating state and operating level

The user selects the required operating mode by pressing the respective button. Each operating mode has a maximum of 2 operating states – with the exception of operating mode "Continuously NORMAL heating" (only 1 operating state).

When the automatic ECO function is active and with quick setback, the operating state is always OFF.

When the operating state is ON, there is a maximum of 3 operating levels, depending on the operating mode. The operating level is determined by the heating program and the holiday program.

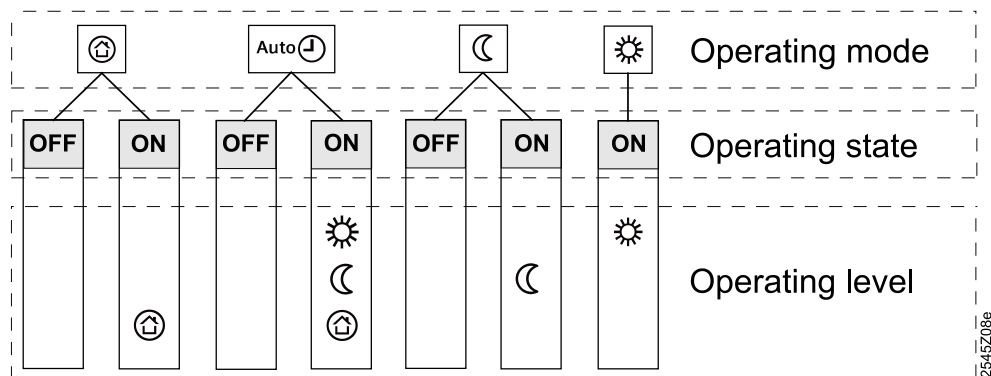

4 Acquisition of measured values

4.1 Room temperature (A6, B5)

4.1.1 Types of sensors

The following choices are available:

- A room sensor QAA24 can be connected to terminal B5. The measuring range is 0...50 °C
- A room unit QAA50.110/101 or QAW70 can be connected to the PPS (point-to-point interface), terminal A6. The measuring range is 0...32 °C.
- One unit can be connected to each of the 2 terminals; in that case, the controller can ascertain the mean value of the 2 measurements, depending on the setting made. Averaging has no impact on the other room unit functions

4.1.2 Error handling

In the event of a short-circuit or an interruption of one of the 2 measuring circuits, the control responds as follows, depending on the room temperature source (setting on operating line 65):

- No sensor (operating line 65 = 0):
A short-circuit or an interruption has no impact on the control. An error message is not delivered
- Room unit connected to terminal A6 (operating line 65 = 1):
In the event of a short-circuit or an interruption, the control continues to operate with the room model, depending on the function. An error message is delivered
- Room sensor connected to terminal B5 (operating line 65 = 2):
In the event of a short-circuit or an interruption, the control continues to operate with the room model, depending on the function. An error message is delivered
- Mean value of A6 and B5 (operating line 65 = 3):
In the event of a short-circuit or an interruption of one of the 2 measuring circuits, the control continues to operate with the correctly working measuring circuit. An error message is delivered.
In the event of a short-circuit or an interruption of both measuring circuits, the control continues to operate with the room model, depending on the function. 2 error messages are delivered
- Automatic selection (operating line 65 = 4):
Since the controller itself decides how it acquires the room temperature, no error messages can be delivered

4.1.3 Room model

The controller features a room model. It simulates the progression of the room temperature. In plants with no acquisition of the room temperature, the room model can provide certain room functions (e.g. quick setback).

For more detailed information, refer to chapter 9.4.6 "Room model temperature".

4.2 Flow temperature (B1)

4.2.1 Types of sensors

Suitable are Siemens sensors operating with a sensing element LG-Ni1000. Averaging with 2 sensors is not possible.

4.2.2 Error handling

A flow sensor with a short-circuit or an interruption always leads to a corresponding error message, irrespective of the type of plant. In that case, the heating circuit pump is activated and the mixing valve on the primary side is driven to the fully closed position when using a mixing circuit, and the heating circuit pump is deactivated when using a pump circuit.

If there is a short-circuit or an interruption and the flow temperature is queried, the display of the QAW70 room unit shows ---.

4.3 Boiler temperature (B2)

4.3.1 Types of sensors

The boiler temperature is required in connection with plant type 3 - x. Suitable are Siemens sensors operating with a sensing element LG-Ni1000.

4.3.2 Error handling

In the event of a short-circuit or an interruption of the measuring circuit, an error is displayed. The plant responds as follows:

- The burner shuts down
- Pump M1 runs continuously

4.4 Outside temperature (B9)

4.4.1 Types of sensors

The following types of sensors can be used:

- Outside sensor QAC22 (sensing element LG-Ni1000)
- Outside sensor QAC32 (sensing element NTC 575)

The controller identifies automatically the type of sensor used. The measuring range is $-50 \dots 50$ °C.

The outside temperature can also be acquired via LPB; refer to chapter 17.5.2 "Outside temperature source".

4.4.2 Error handling

In the event of a short-circuit or an interruption of the measuring circuit, the controller responds as follows, depending on the outside temperature source:

- Controller not connected to data bus (LPB):
The control operates with a fixed outside temperature of 0 °C. An error message is delivered
- Controller connected to data bus (LPB):
If the outside temperature is available via data bus, it is used. An error message is not delivered (this is the normal status in interconnected plants!). But if no outside temperature is available via data bus, the control uses a fixed outside temperature of 0 °C. In that case, an error message is delivered

4.5 Return temperature (B7)

4.5.1 Types of sensors

Suitable are Siemens sensors operating with a sensing element LG-Ni1000. This measured value is required for minimum and maximum limitation of the return temperature.

In interconnected plants (RVP340 or RVP350), the return temperature with plant type 1 - x can be acquired via data bus. Controllers with plant type 1 - x and connected sensor forward the return temperature via data bus.

4.5.2 Error handling

If, in the event of a short-circuit or an interruption of the measuring circuit, the controller requires the return temperature, it responds as follows:

- If a return temperature from a controller in the same segment is available via data bus, it is used (only with plant type 1- x). No error message is delivered since this is the normal status in interconnected plants
- If a return temperature signal is not available via data bus, the return temperature limitation functions are deactivated and an error message is delivered

4.6 Storage tank temperature (B31, B32)

4.6.1 Types of sensors

The storage tank temperature can be acquired as follows:

- With 1 or 2 sensors operating with a sensing element LG-Ni1000, or
- With 1 or 2 thermostats

Solar d.h.w. heating must always be effected with 1 or 2 sensors.

4.6.2 Error handling

The controller's response to errors in the measuring circuit depends on the setting made on operating line 126 (d.h.w. storage tank sensor/thermostat).

1 storage tank sensor
(operating line 126 = 0)

In the event of a short-circuit or an interruption of one of the 2 measuring circuits, the controller continues to operate with the other measuring circuit, if possible. An error message is not delivered.

If both measuring circuits do not produce a valid measured value, an error message is delivered. D.h.w. is no longer heated; the charging pump will be deactivated.

2 storage tank sensors (operating line 126 = 1)	<p>In the event of a short-circuit or an interruption of one of the 2 measuring circuits, the controller continues to operate with the other measuring circuit. An error message is delivered.</p> <p>If both measuring circuits do not produce a valid measured value, 2 error messages are delivered. D.h.w. is no longer heated; the charging pump will be deactivated.</p>
1 storage tank thermostat (operating line 126 = 2)	<p>If there is neither an interruption (thermostat open) nor a short-circuit (thermostat closed) in measuring circuit B31, an error message is delivered. D.h.w. is no longer heated; the charging pump will be deactivated.</p>
2 storage tank thermostats (operating line 126 = 3)	<p>If there is neither an interruption (thermostat open) nor a short-circuit (thermostat closed) in one of the measuring circuits, an error message is delivered. The controller continues to operate with the correctly working measuring circuit.</p> <p>If there is neither an interruption (thermostat open) nor a short-circuit (thermostat closed) in both measuring circuits, 2 error messages are delivered. D.h.w. is no longer heated; the charging pump will be deactivated.</p>
1 storage tank sensor for solar d.h.w. heating (operating line 126 = 4)	<p>In the event of a short-circuit or an interruption of one of the 2 measuring circuits, the controller continues to operate with the other measuring circuit, if possible. An error message is not delivered.</p> <p>If both measuring circuits do not produce a valid measured value, an error message is delivered. D.h.w. is no longer heated; the charging pump and the collector pump will be deactivated.</p>
2 storage tank sensors for solar d.h.w. heating (operating line 126 = 5)	<p>In the event of a short-circuit or an interruption of one of the 2 measuring circuits, the controller continues to operate with the other measuring circuit. An error message is delivered.</p> <p>If both measuring circuits do not produce a valid measured value, 2 error messages are delivered. D.h.w. is no longer heated; the charging pump and the collector pump will be deactivated.</p> <p>If a measured value of the d.h.w. temperature is not available and the temperature is queried, the QAW70 room unit displays ---.</p>

4.7 Collector temperature (B6)

4.7.1 Type of sensor

The collector temperature is acquired by a Siemens sensor operating with a sensing element LG-Ni1000 and an extended measuring range.

4.7.2 Error handling

In the event of an interruption of the measuring circuit, an error message is delivered with a delay of 12 hours and the collector pump is deactivated. This means that solar d.h.w. heating is no longer provided.

5 Function block: End-user space heating

This function block provides settings that the end-user himself can make.

5.1 Operating lines

<i>Line</i>	<i>Function, parameter</i>	<i>Factory setting (range)</i>	<i>Unit</i>
1	Room temperature setpoint for NORMAL heating	20.0 (0...35)	°C
2	Room temperature setpoint for REDUCED heating	14.0 (0...35)	°C
3	Room temperature setpoint for holiday/protection mode	10.0 (0...35)	°C
4	Weekday, for entering the heating program	1-7 (1...7 / 1-7)	-
5	1st heating phase, start of NORMAL heating	06:00 (00:00...24:00)	hh:mm
6	1st heating phase, end of NORMAL heating	22:00 (00:00...24:00)	hh:mm
7	2nd heating phase, start of NORMAL heating	--:-- (00:00...24:00)	hh:mm
8	2nd heating phase, end of NORMAL heating	--:-- (00:00...24:00)	hh:mm
9	3rd heating phase, start of NORMAL heating	--:-- (00:00...24:00)	hh:mm
10	3rd heating phase, end of NORMAL heating	--:-- (00:00...24:00)	hh:mm
12	Date of first day	--:-- (01.01...31.12)	dd:mm
13	Date of last day	--:-- (01.01...31.12)	dd:mm
14	Heating curve, flow temperature setpoint at an outside temperature of 15 °C	30 (20...70)	°C
15	Heating curve, flow temperature setpoint at an outside temperature of -5 °C	60 (20...120)	°C

5.2 Setpoints

5.2.1 General

The setpoints for the NORMAL and the REDUCED room temperature and for holiday/protection mode are entered directly in °C room temperature. They are independent of whether or not the control uses a room sensor.

5.2.2 Frost protection for the building

The lowest valid room temperature setpoint always corresponds to at least the setpoint for holiday/protection mode (setting on operating line 3), even if lower setpoints for the NORMAL and the REDUCED room temperature have been entered (settings on operating lines 1 and 2).

If a room sensor is used and the room temperature falls below the setpoint for holiday/protection mode, the automatic ECO function – if available – aborts the OFF mode until the room temperature has risen 1 °C above the setpoint for holiday/protection mode.

5.3 Heating program

Caution

The heating program offers a maximum of 3 heating phases per day; in addition, every weekday can have different heating phases.

The inputs to be made are not the switching times, but the periods of time during which the NORMAL room temperature shall be maintained. These periods of time are usually identical with the building's occupancy times. The effective switching times for changing from the REDUCED to the NORMAL room temperature, and vice versa, are calculated by the optimization function (precondition: optimization is activated).

Using setting "1-7" on operating line 4, a heating program applying to all weekdays can be entered. This simplifies the settings. If weekend times differ, enter the times for the entire week first, then change days 6 and 7 as required.

The entries are sorted and overlapping heating phases are combined.

5.4 Holiday program

One holiday period per year can be programmed. At 00:00 of the first day of the holiday period, switching over to the setpoint for holiday/protection mode takes place. At 24:00 of the last day of the holiday period, the controller switches to NORMAL or REDUCED heating in accordance with the time switch settings.

The settings for the holiday period are cleared as soon as the holidays have elapsed. The holiday function switches off d.h.w. heating and the circulating pump, depending on the settings made on operating line 121.

The holiday program is only active in AUTO mode.

5.5 Heating curve

The heating curve can be adjusted on operating lines 14 and 15. For more detailed information, refer to chapter 9.6 "Heating curve".

6 Function block: End-user d.h.w.

This function block provides settings for the d.h.w. temperature that the end-user himself can make.

6.1 Operating lines

<i>Line</i>	<i>Function, parameter</i>	<i>Factory setting (range)</i>	<i>Unit</i>
26	NORMAL setpoint for d.h.w. temperature	55 (20...100)	°C
27	Display of current d.h.w. temperature	Display function	°C
28	REDUCED setpoint for d.h.w. temperature	40 (8...80)	°C

6.2 Setpoints

The d.h.w. temperature setpoints are to be entered in °C. When using thermostats, it must be made certain that the NORMAL setpoint entered here agrees with the setpoint of the thermostat or – if 2 thermostats are used – of both thermostats. If there is a deviation, the charging temperature cannot be correctly calculated (charging temperature = setpoint [operating line 26] + boost of charging temperature [operating line 127]).

If d.h.w. heating is switched to the electric immersion heater, setpoint adjustment becomes inactive, since the thermostat of the electric immersion heater ensures temperature control of the storage tank.

The d.h.w. temperature setpoints for NORMAL and REDUCED are used when the d.h.w. heating mode is set to ON.

With OFF and during holiday periods, the frost protection setpoint applies.

6.2.1 NORMAL d.h.w. temperature setpoint

As soon as d.h.w. charging is released, the controller tries to heat up the storage tank until the "NORMAL setpoint of d.h.w. temperature" is reached (operating line 26).

Release of d.h.w. charging always takes place according to the settings made on operating line 123 (always according to heating program or scheduler program 2).

6.2.2 REDUCED d.h.w. temperature setpoint

Outside the release times for charging to the NORMAL setpoint of the d.h.w. temperature, the d.h.w. is heated up to the REDUCED setpoint (operating line 28).

Note

When using thermostats, the REDUCED setpoint of the d.h.w. temperature is deactivated since the thermostat determines the switch on/off temperature.

6.3 Actual value

Operating line 27 displays the current d.h.w. temperature. When using 2 d.h.w. sensors (B31 and B32), the temperature of the "warmer" sensor is displayed.

When using thermostats, the actual value of the d.h.w. temperature cannot be displayed. In that case, the display shows ---.

7 Function block: End-user general

This function block provides settings that the end-user himself can make, plus indication of faults.

7.1 Operating lines

<i>Line</i>	<i>Function, parameter</i>	<i>Factory setting (range)</i>	<i>Unit</i>
31	Weekday, for entering scheduler program 2	1-7 (1...7, 1-7)	
32	Start of 1st ON phase	05:00 (--:-- / 00:00...24:00)	hh:mm
33	End of 1st ON phase	22:00 (--:-- / 00:00...24:00)	hh:mm
34	Start of 2nd ON phase	--:-- (--:-- / 00:00...24:00)	hh:mm
35	End of 2nd ON phase	--:-- (--:-- / 00:00...24:00)	hh:mm
36	Start of 3rd ON phase	--:-- (--:-- / 00:00...24:00)	hh:mm
37	End of 3rd ON phase	--:-- (--:-- / 00:00...24:00)	hh:mm
38	Time of day	(00:00...23:59)	hh:mm
39	Weekday	Display function	
40	Date	(01.01. ... 31.12.)	dd:mm
41	Year	(2009...2099)	yyyy
50	Faults	Display function	

7.2 Scheduler program 2

Scheduler program 2 can be used for one or several of the following functions:

- As a scheduler program for the circulating pump
- As a scheduler program for the release of d.h.w. heating

Scheduler program 2 of the controller allows up to 3 ON phases per day; also, every weekday can have different ON phases.

As with the heating program, it is not the switching times that are to be entered, but the periods of time during which the program or the controlled function shall be active.

Using setting "1-7" on operating line 31, a scheduler program that applies to all weekdays can be entered. This simplifies the settings. If weekend times differ, first enter the times for the entire week, then change days 6 and 7 as required. The entries are sorted and overlapping ON phases are combined.

7.3 Time of day and date

The RVP3.. controllers have a yearly clock for entering the time of day, the weekday and the date.

The weekday on operating line 39 is automatically determined according to the set date and cannot be changed.

The change from summertime to wintertime, and vice versa, is made automatically. Should the respective regulations change, the changeover dates can be adjusted (refer to chapter 17 "Function block: Service functions and general settings").

7.4 Faults

The following faults are displayed:

Number	Error
10	Fault outside sensor B9
20	Fault boiler sensor B2
30	Fault flow sensor B1
40	Fault primary return sensor B7
50	Fault storage tank sensor/thermostat B31
52	Fault storage tank sensor/thermostat B32
60	Fault room sensor B5
61	Fault room unit A6
62	Device with wrong PPS identification connected
73	Fault collector sensor B6
81*	Short-circuit on data bus (LPB)
82*	2 devices with the same bus address (LPB)
86	Short-circuit PPS
100*	2 clock masters on the data bus (LPB)
140*	Inadmissible bus address (LPB)

* These fault displays are only possible with RVP340 and RVP350

If a fault occurs, the LCD displays **Er**.

In interconnected plants, the address (device and segment number) of the controller causing the fault is displayed on all the other controllers. But no address appears on the controller that caused the fault.

Example of display in interconnected plants:

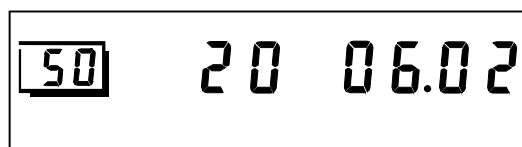

50 = operating line
20 = error number
06 = segment number (LPB)
02 = device number (LPB)

The error message disappears only after the fault has been rectified. There is no acknowledgement!

8 Function block: Plant configuration

This function block only provides selection of the plant type:

8.1 Operating line

Line	Function, parameter		Factory setting (range)
51	Plant type	RVP340	1-0 (1-0, 2-0)
		RVP35..	3-1 (1-1, 3-0, 3-1)

8.2 General

When commissioning a plant, the respective plant type must be entered first on the RVP340 or RVP35.. This ensures that the functions required for the specific type of plant, the parameters and operating lines for the settings and displays are activated.

All plant-specific variables and operating lines for use with the other plant types will be hidden. They will not appear on the display.

Example of entry:

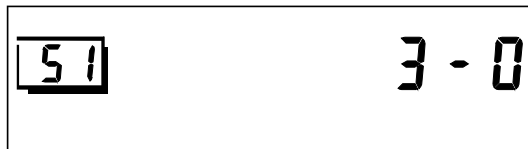

3 = heating circuit type 3
0 = d.h.w. type 0

9 Function block: Space heating

This function block performs the automatic ECO function, the optimization functions with boost heating and quick setback, plus room influence.

9.1 Operating lines

Line	Function, parameter	Factory setting (range)	Unit
61	NORMAL heating limit (ECO day)	17.0 (-- / -5...25)	°C
62	REDUCED heating limit (ECO night)	5.0 (-- / -5...25)	°C
63	Building time constant	20 (0...50)	h
64	Quick setback	1 (0 / 1)	
65	Room temperature source	A (0...3 / A)	
66	Type of optimization	0 (0 / 1)	
67	Maximum heating up period	00:00 (00:00...42:00)	h
68	Maximum early shutdown	0:00 (0:00...6:00)	h
69	Maximum limitation room temperature	-- (-- / 0...35)	°C
70	Influence of room temperature (gain factor)	4 (0...20)	
71	Boost of room temperature setpoint on boost heating	5 (0...20)	°C

9.2 Automatic ECO function

The automatic ECO function controls space heating depending on demand. It gives consideration to the progression of the room temperature depending on the type of building structure as the outside temperature varies. If the amount of heat stored in the house or building is sufficient to maintain the room temperature setpoint currently required, the heating is switched off.

The automatic ECO function ensures that the heating system operates only, or uses energy only, when indeed required.

9.2.1 Compensating and auxiliary variables

The compensating and auxiliary variables considered by the automatic ECO function are the progression of the outside temperature and the heat storage capacity of the building.

The following variables are taken into account:

- The building time constant: This is a measure of the type of building structure and indicates how quickly the room temperature would vary if the outside temperature suddenly changed. The following guide values can be used for setting the building time constant: 10 hours for light, 25 hours for medium, and 50 hours for heavy building structures
- The current outside temperature (T_A)
- The composite outside temperature (T_{AM}). It is the mean value of ...
 - the current outside temperature,
 - the outside temperature filtered by the building time constant

Compared with the current outside temperature, the composite outside temperature is attenuated. Hence, it represents the impact of short-time outside temperature variations on the room temperature as they often occur during intermediate seasons (spring and autumn).

- The attenuated outside temperature (T_{AD}): It is generated by double-filtering the current outside temperature by the building time constant. This means that – in comparison with the current outside temperature – the attenuated outside temperature is considerably dampened. This ensures that no heating is provided in the summer when – because the outside temperature drops for a few days – the heating would normally be switched on

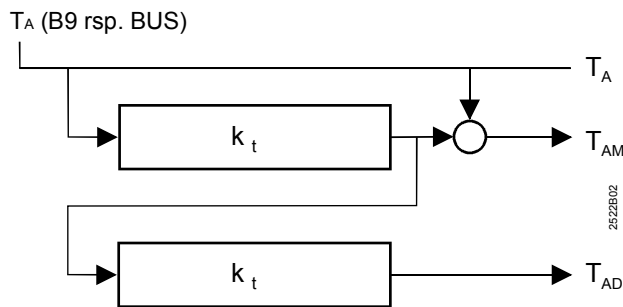

Generation of composite and attenuated outside temperature

T_A	Current outside temperature	T_{AM}	Composite outside temperature
T_{AD}	Attenuated outside temperature	k_t	Building time constant

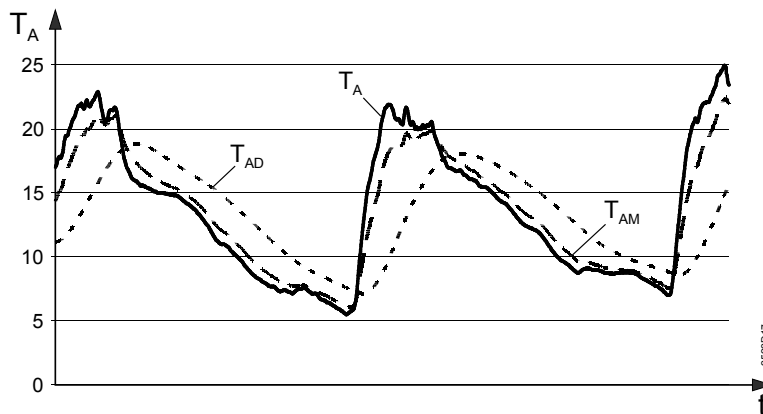

Progression of current, composite and attenuated outside temperature

T_A	Current outside temperature	T_{AM}	Composite outside temperature
T_{AD}	Attenuated outside temperature	t	Time

9.2.2 Heating limits

2 heating limits can be set:

- "ECO day" for NORMAL heating
- "ECO night" for the lower temperature level. This can be REDUCED heating or OFF (holiday/protection mode)

In both cases, the heating limit is the outside temperature at which the heating shall be switched on or off. The switching differential is 1 °C.

9.2.3 Mode of operation

The heating is switched off when **one** of the 3 following conditions is satisfied:

- The current outside temperature exceeds the current ECO heating limit
- The composite outside temperature exceeds the current ECO heating limit
- The attenuated outside temperature exceeds the "ECO day" heating limit

Switching the heating off

In all these cases, the assumption is made that the amount of heat entering the building from outside, or the amount of heat stored in the building structure, is sufficient to maintain the required room temperature level.

When the automatic ECO function switches the heating off, the display shows **ECO**.





Switching the heating on

The heating is switched on again only when the 3 following conditions are satisfied:

- The current outside temperature has fallen 1 °C below the current ECO heating limit
- The composite outside temperature has fallen 1 °C below the current ECO heating limit
- The attenuated outside temperature has fallen 1 °C below the "ECO day" heating limit

Operating modes and operating states

The action of the automatic ECO function depends on the operating mode:

Operating mode or operating state	Automatic ECO function	Current heating limit
Auto  Automatic operation	Active	ECO day or ECO night
 Continuously REDUCED heating	Active	ECO night
 Continuously NORMAL heating	Inactive	–
 Protection/holiday mode	Active	ECO night
 Manual control	Inactive	–

9.3 Room temperature source

The outside temperature source can be selected via operating line 65. The following settings can be made:

Op. line 65	Room temperature source
0	No room sensor
1	Room unit connected to terminal A6
2	Room sensor connected to terminal B5
3	Mean value of the devices connected to terminals A6 and B5
A	Automatic selection

In addition, the room temperature source used by the controller is shown on operating line 65 and appears as a number on the right side of the LCD:

0 = controller operates without sensor

1 = controller operates with room unit connected to terminal A6

2 = controller operates with room unit connected to terminal B5

3 = controller operates with mean value of the devices connected to A6 and B5

9.4 Optimization

9.4.1 Definition and purpose

Operation of the heating system is optimized. EN 12 098 defines optimization as automatic shifting of the switch-on and switch-off points aimed at saving energy. This means that...

- switching on and heating up as well as switching off are controlled such that during building occupancy times the required room temperature level is always ensured,
- the smallest possible amount of heating energy is used to achieve this objective.

9.4.2 Basics

It is possible to select or set ...

- the type of optimization; either with a room sensor/room unit or according to the room model,
- the maximum heating up time,
- maximum early shutdown,
- quick setback (yes or no).

For optimization, the controller considers either the current room temperature – acquired by a room sensor or room unit – or the room model.

9.4.3 Optimization with room sensor

When using a room sensor/room unit, it is possible to have **both** optimized switching on and optimized switching off.

To be able to optimally determine the switch-on and switch-off points, optimization needs to "know" the building's heating up and cooling down characteristics, always as a function of the prevailing outside temperature. For this purpose, optimization constantly acquires the room temperature and the prevailing outside temperature. It captures these variables via the room sensor and the outside sensor and continually adjusts the forward shift of the switching points. This way, optimization can also detect changes made to the house or building and take them into consideration.

The learning process always concentrates on the first heating phase per day.

9.4.4 Optimization without room sensor

Without room sensor, **only** optimized switching on is possible.

Optimization operates with fixed values (no learning process), based on the set maximum heating up time and the room model.

9.4.5 Process

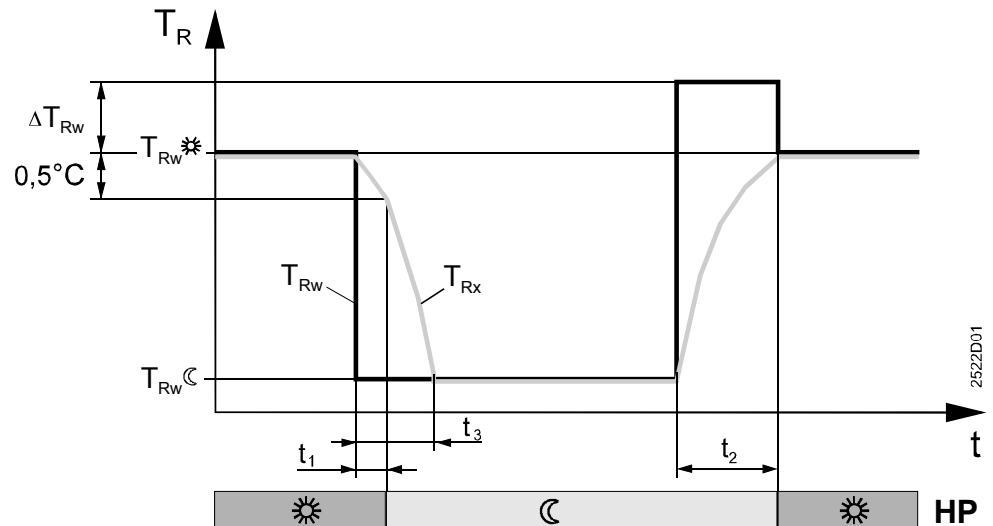

- HP Heating program
 T_R Room temperature
 t Zeit
 t_1 Forward shift for early shutdown
 t_2 Forward shift to start heating up
 t_3 Quick setback
 T_{Rw} Room temperature setpoint
 T_{Rw}^* Setpoint for NORMAL room temperature
 $T_{Rw}^{(C)}$ Setpoint for REDUCED room temperature
 ΔT_{Rw} Boost of room temperature setpoint (with boost heating)
 T_{Rx} Actual value of room temperature

9.4.6 Room model temperature

To determine the room temperature generated by the room model, a distinction must be made between 2 cases:

- The controller is not in quick setback mode:
The room temperature according to the room model is identical to the current room temperature setpoint
- The controller is in quick setback mode:
The room temperature used by the room model is calculated according to the following formula:

$$\text{Room model temperature } T_{RM} \text{ [}^\circ\text{C]} = (T_{Rw}^* - T_{AM}) \times e^{-\frac{t}{3 \times kt}} + T_{AM}$$

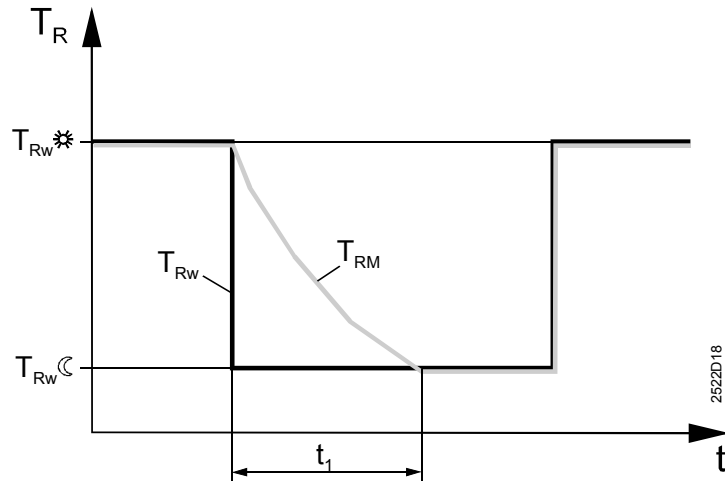

Progression of room temperature generated by the room model

e	2.71828 (basis of natural logarithms)	T_R	Room temperature
k_t	Building time constant in hours	T_{RM}	Room model temperature
t	Time in hours	T_{RW}^*	Setpoint for NORMAL room temperature
t_1	Quick setback	T_{RW}^C	Setpoint for REDUCED room temperature
T_{AM}	Composite outside temperature		

9.4.7 Optimized switching off

During the building's occupancy time, the controller maintains the setpoint for NORMAL heating. Toward the end of the occupancy time, the control system switches to the setpoint for REDUCED heating. Optimization calculates the switch-over point such that, when occupancy ends, the room temperature will lie 0.5 °C below the setpoint for NORMAL heating (early shutdown).

Optimized switching off can be deactivated by entering 0 hours for maximum early shutdown.

9.4.8 Quick setback

When changing from the NORMAL temperature to a lower temperature level (REDUCED or holidays/frost), the heating is shut down. It remains shut down until the setpoint for the lower temperature level is reached.

- With room sensor, the actual value of the room temperature is taken into account
- Without room sensor, the actual value is simulated by the room model. The duration of quick setback is then calculated according to the following formula:

$$t \text{ [h] } = 3 \cdot k_t \cdot \left(- \ln \frac{T_{RW}^C - T_{AM}}{T_{RW}^* - T_{AM}} \right)$$

where:

ln	Natural logarithm
k_t	Building time constant in hours
t	Duration of quick setback
T_{AM}	Composite outside temperature
T_{RW}^*	Setpoint for NORMAL room temperature
T_{RW}^C	Setpoint for REDUCED room temperature

9.4.9 Optimized switching on

During nonoccupancy times, the controller maintains the setpoint for REDUCED heating. Toward the end of the nonoccupancy time, optimization switches the control to boost heating; this means that the set boost is added to the room temperature setpoint. Optimization calculates the switchover point such that, when occupancy starts, the room temperature will have reached the setpoint for NORMAL heating.

When the room temperature is simulated by the room model – that is, without room sensor – the forward shift is calculated as follows:

$$t \text{ [min] } = (T_{Rw}^* - T_{RM}) * k_t * 3$$

where:

t Forward shift
 T_{Rw}^* Setpoint for NORMAL room temperature
 T_{RM} Room model temperature
 k_t Building time constant in hours

Optimized switching on with the room model is effected only if, previously, quick setback took place.

Optimized switching on can be deactivated by entering 0 hours for the maximum heating up time.

9.4.10 Boost heating

For boost heating, a room temperature setpoint boost can be set.

After switching over to the NORMAL temperature, the higher room temperature setpoint applies, resulting in an appropriately higher flow temperature setpoint.

D.h.w. heating during boost heating does not affect the latter.

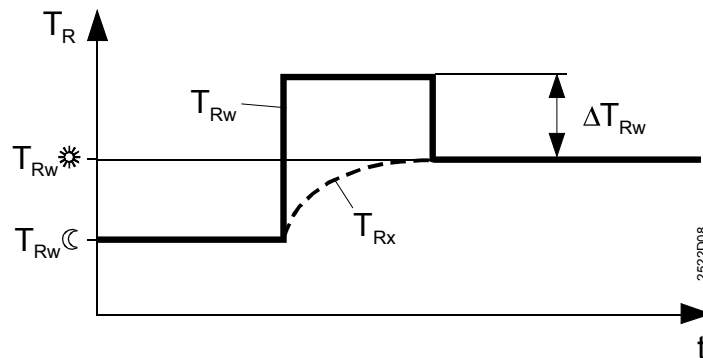

t Time
 T_R Room temperature
 T_{Rw}^* Setpoint for NORMAL room temperature
 T_{Rw}^{C} Setpoint for REDUCED room temperature
 T_{Rx} Actual value of room temperature
 T_{Rw} Room temperature setpoint
 ΔT_{Rw} Boost of room temperature setpoint (with boost heating)

Duration of boost:

- When using a room sensor, the boost is maintained until the room temperature has reached the setpoint for NORMAL heating. Then, this setpoint applies again
- Without room sensor, the room model calculates how long the boost will be maintained. The duration is calculated according to the following formula:

$$t_1 \text{ [h] } = 2 * \frac{T_{Rw}^* - T_{RM1}}{T_{Rw}^* - T_{Rw}^{\text{C}}} * \frac{k_t}{20}$$

The duration of boost is limited to 2 hours.

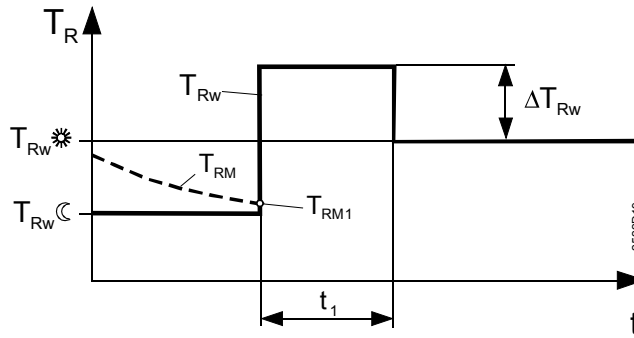

where:

- k_t Building time constant in hours
- t Time
- t_1 Duration of boost of room temperature setpoint with boost heating
- T_R Room temperature
- T_{Rw} ☀ Setpoint for NORMAL room temperature
- T_{Rw} ☾ Setpoint for REDUCED room temperature
- T_{RM} Room model temperature
- T_{RM1} Room model temperature when boost heating is started
- T_{Rw} Room temperature setpoint
- ΔT_{Rw} Boost of room temperature setpoint (with boost heating)

9.5 Room functions

9.5.1 Maximum limitation of room temperature

For the room temperature, it is possible to have adjustable maximum limitation. Required for that purpose is a room sensor or room unit. A room temperature lying 1 °C above the limit value leads to a room temperature setpoint reduction of 4 °C.

Maximum limitation of the room temperature is independent of the setting made for the room influence.

If the room temperature lies above the limit value, the display shows r .

The flow temperature setpoint reduction ΔT_{Vw} is calculated as follows:

$$\Delta T_{Vw} \text{ [K]} = \Delta T_{Rw} * (1 + s)$$

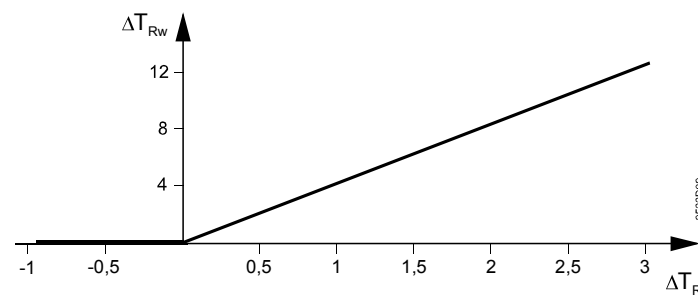

- s Heating curve slope
- ΔT_{Rw} Room temperature setpoint reduction
- ΔT_R Deviation of the room temperature
- ΔT_{Vw} Flow temperature setpoint reduction

9.5.2 Room influence

The room temperature is included in the control process. Required for that purpose is a room sensor or room unit.

A gain factor for the room temperature's influence on flow temperature control can be adjusted. This gain factor indicates to what extent deviations of the current room temperature from the room temperature setpoint have an impact on flow temperature control:

0 = no impact of room temperature deviation on the generation of setpoint

20 = maximum impact of room temperature deviation on the generation of setpoint

The room temperature setpoint change ΔT_{Rw} is calculated according to the following formula:

$$\Delta T_{Rw} \text{ [K]} = \frac{VF}{2} * (T_{Rw} - T_{Rx})$$

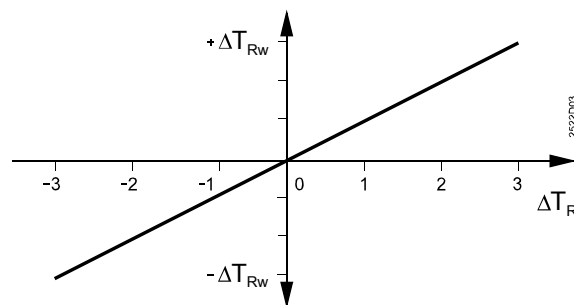

The flow temperature setpoint change ΔT_{Vw} resulting from the change of room temperature setpoint is calculated as follows:

$$\Delta T_{Vw} \text{ [K]} = \Delta T_{Rw} * (1 + s)$$

s	Heating curve slope
T_{Rw}	Room temperature setpoint
ΔT_{Rw}	Change of room temperature setpoint
$-\Delta T_{Rw}$	Reduction of room temperature setpoint
$+\Delta T_{Rw}$	Increase of room temperature setpoint
T_{Rx}	Actual value of room temperature
ΔT_R	Deviation of room temperature ($T_{Rw} - T_{Rx}$)
ΔT_{Vw}	Change of flow temperature setpoint
VF	Gain factor

9.6 Heating curve

9.6.1 Purpose

With space heating systems, flow temperature control is always weather-compensated. The heating curve assigns the flow temperature setpoint to the prevailing outside temperature.

9.6.2 Settings

The heating curve settings are made via 2 operating lines.

The following settings are required:

- Flow temperature setpoint at an outside temperature of $-5\text{ }^{\circ}\text{C}$
- Flow temperature setpoint at an outside temperature of $15\text{ }^{\circ}\text{C}$

The basic settings during the commissioning phase are made based on the planning documentation or according to local practices.

They are made on operating lines 14 and 15:

Op. line	Setpoint
14	Flow temperature setpoint at an outside temperature of 15 °C
15	Flow temperature setpoint at an outside temperature of –5 °C

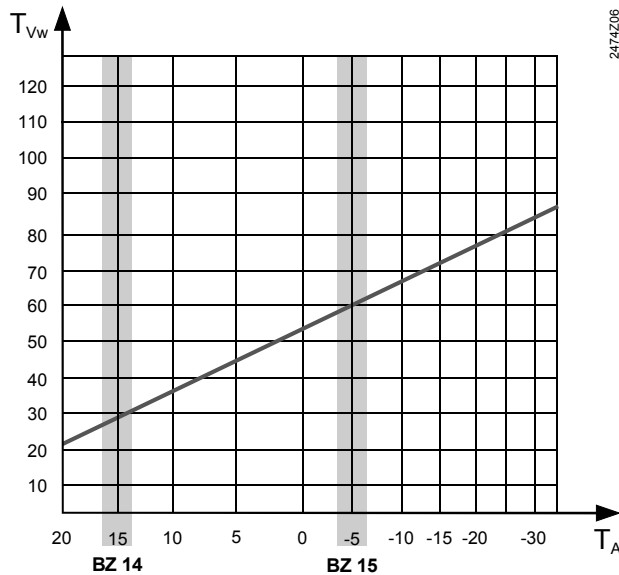

Heating curve diagram showing the basic settings

BZ 14 Setting operating line 14, flow temperature setpoint at an outside temperature of 15 °C

BZ 15 Setting operating line 15, flow temperature setpoint at an outside temperature of –5 °C

T_A Outside temperature

T_{Vw} Flow temperature setpoint

9.6.3 Deflection

The heat losses of buildings are proportional to the difference of room temperature and outside temperature. By contrast, the heat output of radiators does not increase proportionally when the difference of radiator and room temperature increases. For this reason, the radiators' heat exchanger characteristic is deflected. The heating curve's deflection takes these properties into consideration.

In the range of small slopes (e.g. with floor heating systems), the heating curve is practically linear – due to the small flow temperature range – and therefore corresponds to the characteristic of low temperature heating systems.

Slope "s" is calculated according to the following formula:

$$s = \frac{T_{Vw(-5)} - T_{Vw(+15)}}{20 \text{ K}}$$

s Heating curve slope

T_{Vw(-5)} Flow temperature setpoint at an outside temperature of –5 °C

T_{Vw(+15)} Flow temperature setpoint at an outside temperature of 15 °C

The heating curve is valid for a room temperature setpoint of 20 °C.

9.6.4 Parallel displacement of heating curve

The heating curve can be shifted parallel, manually with the knob for room temperature readjustments. This readjustment is made by the end-user and covers a range of $-4.5\dots+4.5$ °C room temperature.

The parallel displacement of the heating curve is calculated as follows:

$$\text{Parallel displacement } \Delta T_{\text{Flow}} = (\Delta T_{\text{Knob}}) * (1 + s)$$

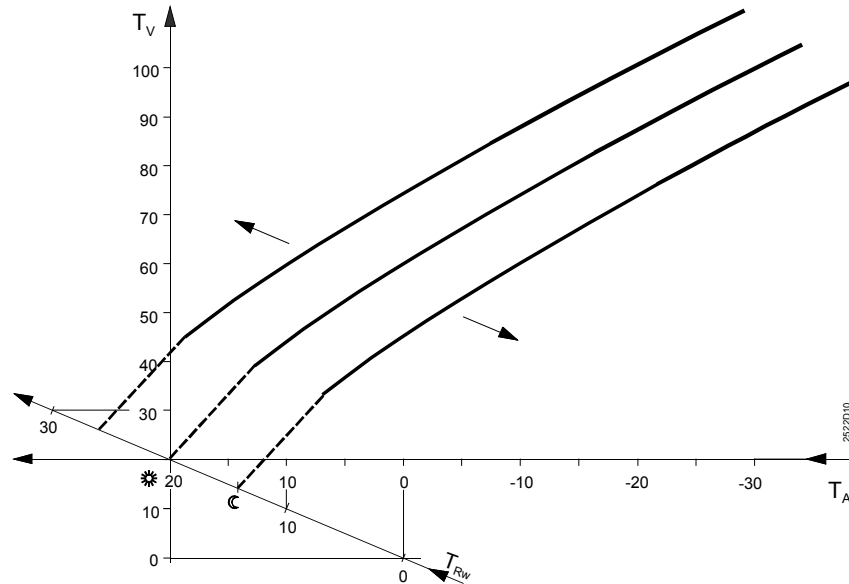

Parallel displacement of heating curve

- s Slope
- T_A Outside temperature
- T_V Flow temperature
- T_{Rw} Room temperature setpoint

9.7 Generation of setpoint

9.7.1 Weather-compensated control

Weather-compensated control is used with all types of plants. The setpoint is generated via the heating curve as a function of the outside temperature. The temperature used is the **composite** outside temperature.

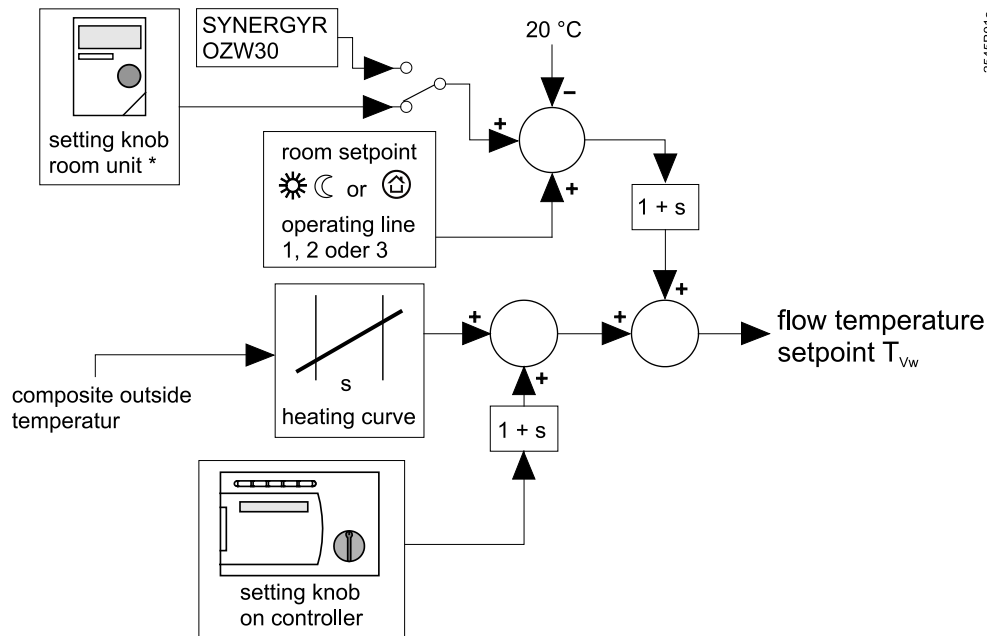

OZW30	SYNERGYR central unit	☀	Room temp. setpoint NORMAL
*	Only active with room unit level ☀	☾	Room temp. setpoint REDUCED
s	Heating curve slope	🏠	Room temp. setpoint holiday / protection

The impact of the OZW30 central unit is described in chapter 20.1.4 "Interplay with SYNERGYR central unit OZW30".

25445B01e

10 Function block: Actuator heating circuit

This function block provides control of the heating circuit. It acts as follows, depending on the type of plant:

- Weather-compensated on the mixing valve of a space heating system
- Weather-compensated on the valve in the primary return of a space heating system with district heat connection

10.1 Operating lines

<i>Line</i>	<i>Function, parameter</i>	<i>Factory setting (range)</i>	<i>Unit</i>
81	Maximum limitation flow temperature	--- (--- / 0...140)	°C
82	Minimum limitation flow temperature	--- (--- / 0...140)	°C
83	Maximum rate of flow temperature increase	--- (--- / 1...600)	K/h
84	Setpoint boost mixing valve/heat exchanger	10 (0...50)	K
85	Actuator running time	120 (30...873)	s
86	P-band of control	32.0 (1...100)	K
87	Integral action time of control	120 (10...873)	s
88	Type of actuator	1 (0 / 1)	
89	Switching differential	2 (1...20)	K

10.2 Limitations

10.2.1 Flow temperature limitations

Settings

The following settings can be made:

- Maximum limitation of flow temperature: At the limit value, the heating curve runs horizontally. This means that the flow temperature setpoint cannot exceed the maximum value; it is limited
- Minimum limitation of flow temperature: At the limit value, the heating curve runs horizontally. This means that the flow temperature setpoint cannot fall below the minimum value; it is limited (not with locking signals)

If the setpoint is limited, the display shows:

┌ = maximum limitation

└ = minimum limitation

Both limitations can be deactivated (setting ---).

Impact on d.h.w. heating

Minimum limitation can be overridden during storage tank charging, depending on the kind of priority.

10.2.2 Setpoint increase

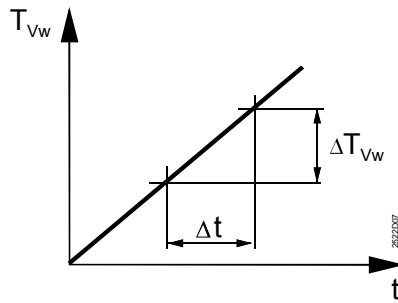

$$\text{Maximum increase: } = \frac{\Delta T_{Vw}}{\Delta t}$$

t Time
Δt Time unit

T_{Vw} Flow temperature setpoint
ΔT_{Vw} Setpoint increase per time unit

The rate of increase of the flow temperature setpoint can be limited to a maximum (heating up brake). In that case, the maximum the flow temperature setpoint can increase is the set temperature per time unit (°C per hour). This function ...

- prevents cracking noises in the piping,
- protects objects and construction materials that are sensitive to quick temperature increases (e.g. antiques),
- prevents excessive loads on the heat source.

This function can be deactivated (setting ---).

10.3 Type of actuator

The type of actuator or type of control can be selected via operating line 88:

0 = 2-position control

1 = 3-position control

10.3.1 2-position control

2-position control operates as weather-compensated flow temperature control. Flow temperature control is provided by the ON/OFF action of the actuating device (valve). The switching differential required for this type of control can be set via operating line 89.

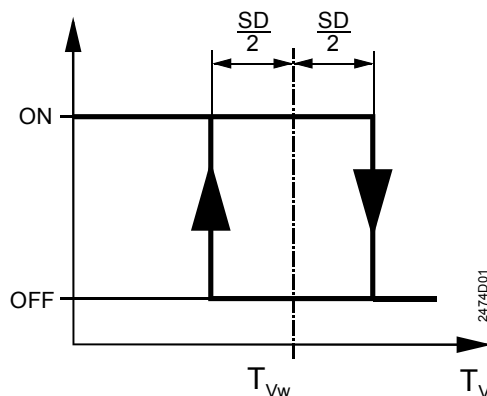

ON Actuator operating
OFF Actuator dead
SD Switching differential (operating line 89)
T_V Flow temperature
T_{Vw} Flow temperature setpoint

10.3.2 3-position control

3-position control operates as weather-compensated PI flow temperature control. The flow temperature is controlled via the modulating actuating device (mixing valve or 2-port valve). There is no proportional offset, owing to the control system's I-action.

10.4 Auxiliary variables in interconnected plants

10.4.1 Temperature boost mixing valve/heat exchanger

A higher mixing valve or heat exchanger temperature can be entered on the controller. This represents an increase of the respective heating zone's flow temperature setpoint. The higher setpoint is forwarded to heat generation as the heat demand signal (in own controller or via data bus).

The increased mixing valve or heat exchanger temperature is set on the controller that drives the mixing valve or 2-port valve (controller N2 in the example below) (operating line 84).

Example:

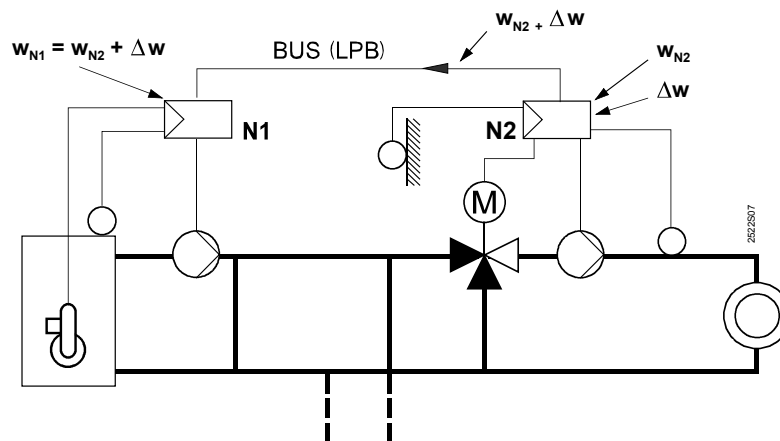

- N1 Boiler temperature controller (heat generation)
- N2 Flow temperature controller (heating zone)
- w_{N1} Setpoint of boiler temperature controller
- w_{N2} Setpoint of flow temperature controller
- Δw Boost of mixing valve temperature (set on controller N2)

10.5 Pulse lock with 3-position actuator

If, during a total period of time equaling 5 times the running time, the 3-position actuator received only CLOSE or only OPEN pulses, additional CLOSE pulses sent by the controller will be locked. This minimizes strain on the actuator.

For safety reasons, however, the controller sends a 1-minute CLOSE pulse at 10-minute intervals.

A pulse in the opposite direction negates the pulse lock.

11 Function block: Boiler

Function block "Boiler" acts as a 2-position controller and is used for direct burner control. It operates as a demand-dependent boiler temperature controller of a common flow, which supplies heat to one or several consumers.

11.1 Operating lines





Line	Function, parameter	Factory setting (range)	Unit
91	Boiler operating mode	0 (0...2)	
92	Maximum limitation boiler temperature	95 (25...140)	°C
93	Minimum limitation boiler temperature	10 (5...140)	°C
94	Switching differential boiler	6 (1...20)	K
95	Minimum limitation burner running time	4 (0...10)	min
96	Burner stage 2 release integral	50 (0...500)	°C*min
97	Burner stage 2 reset integral	10 (0...500)	°C*min
98	Burner stage 2 locking time	20 (0...40)	min
99	Operating mode pump M1	1 (0 / 1)	

11.2 Operating mode

The boiler's operating mode for situations when there is no demand for heat (e.g. due to the automatic ECO function) can be selected. There is a choice of 3 operating modes:

- With manual shutdown: The boiler is shut down when there is no heat request and protection mode  is selected (setting 0 on operating line 91)
- With automatic shutdown: The boiler is shut down when there is no heat request, irrespective of the selected operating mode (setting 1 on operating line 91)
- Without shutdown: The boiler is never shut down; it always maintains the minimum setpoint (setting 2 on operating line 91)

The table applies when there is no demand for heat.

Operating mode of controller		Operating mode of boiler		
		Manual shutdown	Automatic shutdown	Without shut-down
	Protection mode	Boiler OFF	Boiler OFF	Boiler at minimum limit value
Auto 	AUTO	Boiler at minimum limit value	Boiler OFF	Boiler at minimum limit value
	REDUCED	Boiler at minimum limit value	Boiler OFF	Boiler at minimum limit value
	NORMAL	Boiler at minimum limit value	Boiler OFF	Boiler at minimum limit value

If there is demand for heat, the boiler always supplies heat, which means that the boiler's operating mode in that case is always ON.

11.3 Limitations

11.3.1 Maximum limitation of boiler temperature

For maximum limitation of the boiler temperature, the maximum limit value can be set. The switch-off point cannot be higher than the maximum limit value. The switch-on point is then lower, the difference being the set switching differential. If the boiler temperature is limited to a maximum, the display shows \lceil .

This maximum limitation is not a safety function; for that purpose, a thermostat or thermal reset limit thermostat, etc., must be used!

11.3.2 Minimum limitation of boiler temperature

For minimum limitation of the boiler temperature, the minimum limit value can be set. The switch-on point cannot fall below the minimum limit value. The switch-off point is then higher, the difference being the set switching differential.

If the boiler temperature is limited to a minimum, the display shows \rfloor .

11.3.3 Actions during d.h.w. heating

Maximum and minimum limitation are also active during d.h.w. heating.

11.4 2-position control

2-position control maintains the required boiler temperature by switching a 1- or 2-stage burner.

11.4.1 Control with 1-stage burner

For 2-position control with a 1-stage burner, the variables that can be set are the switching differential and the minimum burner running time.

The controller compares the actual value of the boiler temperature with the setpoint. If the boiler temperature falls by half the switching differential below the setpoint, the burner is switched on. If the boiler temperature exceeds the setpoint by half the switching differential, the burner is switched off.

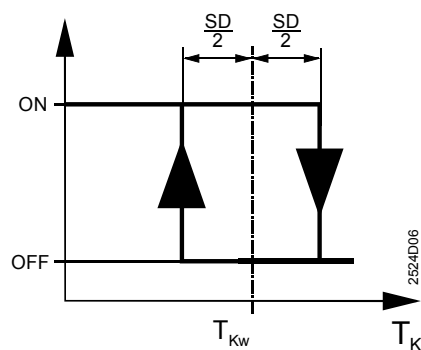

SD Switching differential
 T_K Boiler temperature
 T_{Kw} Boiler temperature setpoint

If there is no more deviation before the minimum burner running time has elapsed, the burner will nevertheless continue to operate until that time has elapsed (burner cycling protection). This means that the minimum burner running time has priority. Maximum limitation of the boiler temperature is maintained, however, which always leads to burner shutdown.

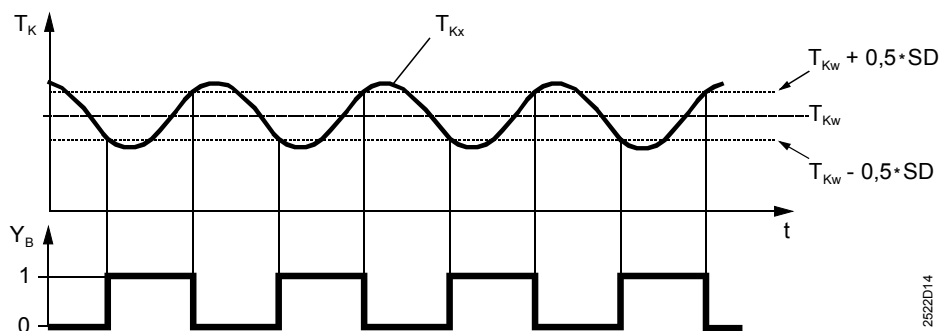

SD	Switching differential	T_{Kw}	Boiler temperature setpoint
t	Time	T_{Kx}	Actual value of boiler temperature
T_{Kx}	Boiler temperature	Y_B	Burner control signal

Note on setting: When controlling a 1-stage burner, the reset integral of the second stage should be set to zero.

11.4.2 Control with 2-stage burner

Setting parameters

For 2-position control with a 2-stage burner, the variables that can be set are the switching differential and the minimum burner running time – the latter now applying to both stages – plus the following variables:

- The release integral (FGI) for the second stage. This is the variable generated from the progression of temperature (T) and time (t). If the maximum limit is exceeded, the second burner stage is released and can be switched on. Prerequisite is that the minimum locking time for the second stage has elapsed.

$$FGI = \int_0^t \Delta T dt \quad \text{where: } \Delta T = (w - 0.5 \cdot SD - x) > 0$$

- The reset integral (RSI). This is a variable generated from the progression of temperature and time. If the maximum limit is exceeded, the burner is locked and shuts down.

$$RSI = \int_0^t \Delta T dt \quad \text{where: } \Delta T = (x - w + 0.5 \cdot SD) > 0$$

- The minimum locking time for the second stage, which is the period of time on completion of which the second stage can switch on at the earliest

Control process

The controller compares the actual value of the flow temperature with the setpoint. If it falls by half the switching differential ($x < w - 0.5 \cdot SD$) below the setpoint, the first burner stage is switched on. At the same time, the minimum waiting time for the second burner stage commences and the release integral is being generated. The controller ascertains for how long and by how much the flow temperature remains below $w - 0.5 \cdot SD$. It continuously generates the integral based on the progression of temperature and time.

If, on completion of the minimum locking time, the flow temperature lies below $w - 0.5 \cdot SD$, and the release integral reaches the set maximum limit, the second burner stage is released and switched on. The flow temperature rises.

If the flow temperature exceeds the setpoint by half the switching differential ($x = w + 0.5 \cdot SD$), the second burner stage is switched off again, but remains

released. The first stage continues to operate. If the flow temperature drops again, the second stage is switched on again at $x < w - 0.5 \cdot SD$. Now, the setpoint is maintained with the help of the second burner stage.

If, however, the flow temperature continues to rise ($x > w + 0.5 \cdot SD$), the controller starts generating the reset integral. It determines for how long and to what extent the flow temperature remains above the setpoint by half the switching differential. It continuously generates the reset integral based on the progression of temperature and time. When the reset integral reaches the set maximum limit, the second burner stage is locked and the first stage is shut down.

The minimum locking time and calculation of the release integral at $x < w - 0.5 \cdot SD$ are started when the switch-on command for the first burner stage is given.

Due to the time-temperature integral, it is not only the duration of the deviation that is considered but also its extent when deciding whether the second stage shall be released or locked.

SD Switching differential
w Boiler temperature setpoint
x Actual value of boiler temperature

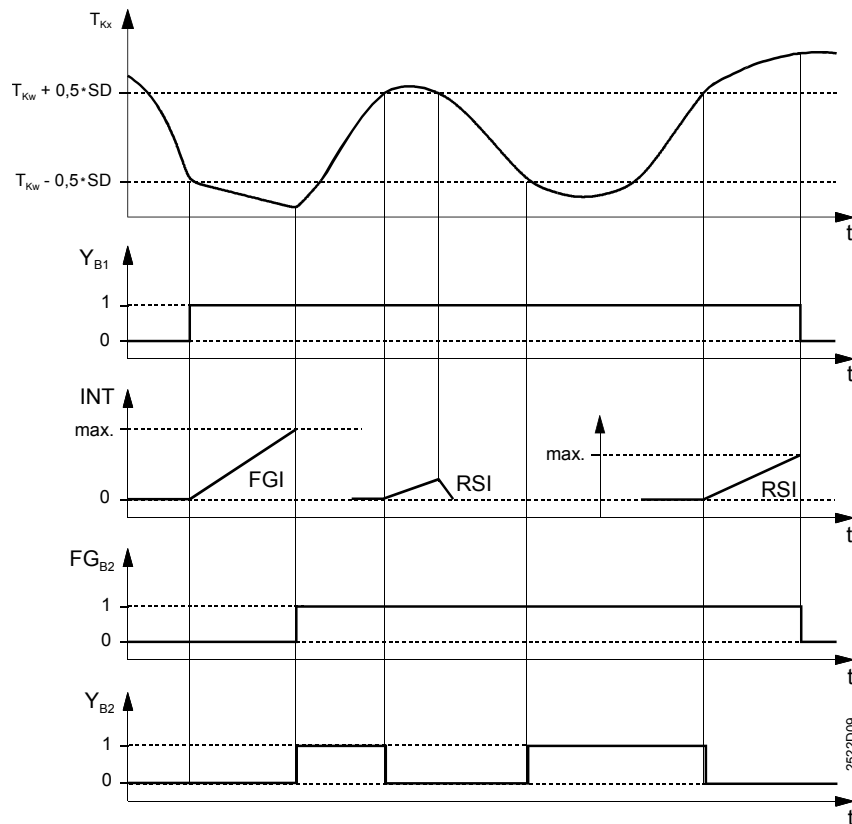

FG _{B2}	Release for burner stage 2	t	Time
FGI	Release integral	T _{Kw}	Boiler temperature setpoint
INT	Integral	T _{Kx}	Actual value of boiler temperature
RSI	Reset integral	Y _{B1}	Control signal for burner stage 1
SD	Switching differential	Y _{B2}	Control signal for burner stage 2

11.4.3 Frost protection for the boiler

Frost protection for the boiler operates with fixed values:

- Switch-on point: 5 °C boiler temperature.
- Switch-off point: Minimum limit of boiler temperature plus switching differential.

If the boiler temperature falls below 5 °C, the burner is always switched on and keeps running until the boiler temperature exceeds its minimum limit by the amount of the switching differential.

11.4.4 Protective boiler startup

If the boiler temperature falls below the minimum limit of the boiler temperature while the burner is running, the temperature differential (minimum limit value minus actual value) is integrated. From this, a critical locking signal is generated and forwarded to the connected consumers. This causes the loads to reduce their setpoints, aimed at consuming less energy. If the critical locking signal exceeds a defined value, the boiler pump is deactivated as well.

If the boiler temperature returns to a level above the minimum limit, the integral is reduced, resulting in a reduction of the critical locking signal.

If the integral falls below a defined level, the boiler pump is activated again. The connected consumers increase their setpoints again.

When the integral reaches the value of zero, protective boiler startup becomes inactive, in which case the critical locking signal is zero.

If protective boiler startup is active, the boiler temperature controller's display shows \lrcorner .

Protective boiler startup cannot be deactivated.

Chapter 17.4.6 "Locking signal gain" provides information on who receives the boiler temperature controller's critical locking signal and how the consumers respond to it.

Autonomous unit

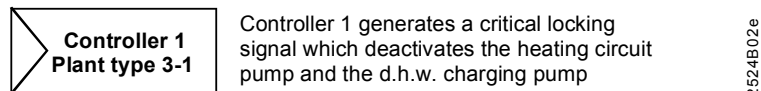

Interconnected plant

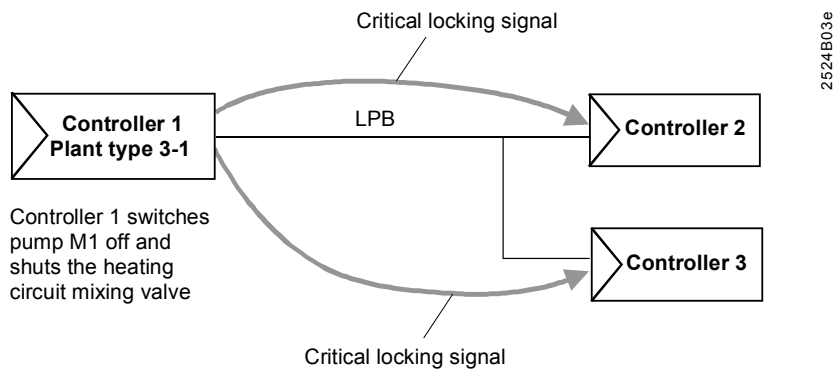

11.4.5 Protection against boiler overtemperatures

To prevent heat from accumulating in the boilers (protection against overtemperature), the controller provides a protective function.

When the first burner stage is shut down, the controller allows pump M1 to run for the set overrun time (operating line 174 on the boiler temperature controller), forwarding at the same time a forced signal to all loads (inside the controller and on the data bus). If the boiler temperature controller is located in segment 0, the forced signal is sent to all consumers in all segments. By contrast, if the boiler temperature controller is located in segment 1...14, the signal is only sent to the consumers in the same segment.

All consumers (heating and d.h.w. circuits) and heat exchangers that abruptly reduce their heat request monitor the data bus during the set pump overrun time to see if a forced signal is being sent by the boiler.

If no forced signal is received, the consumers and heat exchangers only perform pump overrun (refer to chapter 17.4.3 "Pump overrun").

- If, in this time window, a forced signal is received, the consumers continue to draw heat from the boiler in the following manner:
 - Plant types with heating circuits using a mixing valve/2-port valve maintain the former setpoint
 - Plant types with pump heating circuits allow the pumps to run

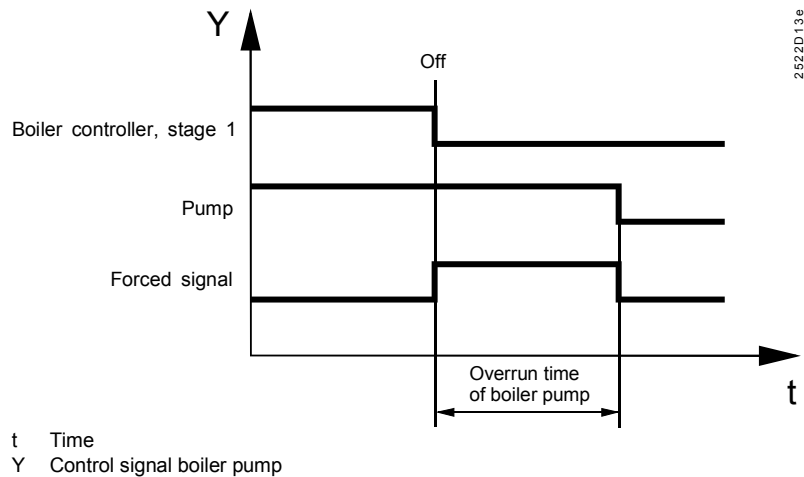

If the boiler sets the forced signal to zero, the consumers and heat exchangers that had responded to the forced signal act as follows:

- They close the mixing valves/2-port valves
- Their pumps continue to run for the set overrun time and then stop

D.h.w. discharging protection takes priority over protection against boiler overtemperatures.

11.5 Operating mode of pump M1

For pump M1, it can be selected via operating line 99 whether or not it shall run during protective boiler startup:

- Circulating pump without deactivation (setting 0):
The circulating pump runs when one of the consumers requests the boiler to supply heat and when burner stage 1 is on, hence, during protective boiler startup also
- Circulating pump with deactivation (setting 1):
The circulating pump runs when one of the consumers requests the boiler to supply heat. During protective boiler startup, the pump is deactivated

12 Function block: Setpoint return temperature limitation

On this function block, the setpoint for minimum limitation of the return temperature or the constant value for shifting maximum limitation of the return temperature can be adjusted.

12.1 Operating line

Line	Function, parameter	Factory setting (range)	Unit
101	Setpoint return temperature limitation, constant value	--- (--- / 0...140)	°C

12.2 Description

The setpoint for minimum limitation of the return temperature (plant types 1 - x and 3 - x) or the constant value for shifting maximum limitation of the return temperature (plant type 2 - x) can be set on operating line 101.

The function can be deactivated by entering ---, which means that the return temperature will not be limited.

For more detailed information about the function, refer to chapter 13 "Function block: District heat".

If the settings of this function block have been locked (refer to the respective section on operating line 248), the display shows *OFF* when pressing \leftarrow and \rightarrow .

12.3 Minimum limitation of return temperature

Wherever possible or required, this function block provides minimum limitation of the boiler return temperature. This applies to ...

- plant type 1 - x, "Space heating with mixing valve", and
- plant type 3 - x, "Space heating with mixing valve and precontrol with boiler".

Minimum limitation of the return temperature prevents boiler corrosion due to flue gas condensation.

12.3.1 Type of sensor

Suitable are Siemens sensors operating with a sensing element LG-Ni1000.

The sensor is to be installed in the return.

With plant type 1 - x, the return temperature signal can also be forwarded via LPB. In interconnected plants, only 1 return temperature sensor per segment may be connected.

12.3.2 Mode of operation

If the return temperature falls below the set minimum limit value, the temperature differential of minimum limit value and actual value is integrated. From this, a critical locking signal is generated and forwarded to the connected consumers. This causes the loads to reduce their setpoints, aimed at consuming less energy.

If the return temperature returns to a level above the minimum limit value, the integral is reduced, resulting in a reduction of the critical locking signal. The connected consumers increase their setpoints again.

When the integral reaches the value of zero, minimum limitation of the return temperature becomes inactive, in which case the critical locking signal is zero.

If minimum limitation of the return temperature is active, the display shows \downarrow .

Minimum limitation of the return temperature can be deactivated.

Chapter 17.4.6 "Locking signal gain" provides information on who receives the critical locking signal and how the consumers respond to it.

The minimum limit value is to be set on operating line 101.

Setting --- = inactive.

12.3.3 Mode of operation with an autonomous unit (without bus)

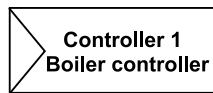

Without minimum limitation of the return temperature

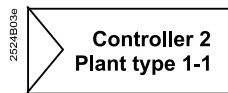

Operating line 101 = 50 °C
Return temperature sensor connected

Controller 2 generates internally a critical locking signal which shuts the heating circuit mixing valve and deactivates the charging pump

12.3.4 Mode of operation in interconnected plants

Variant 1 Central impact of limitation

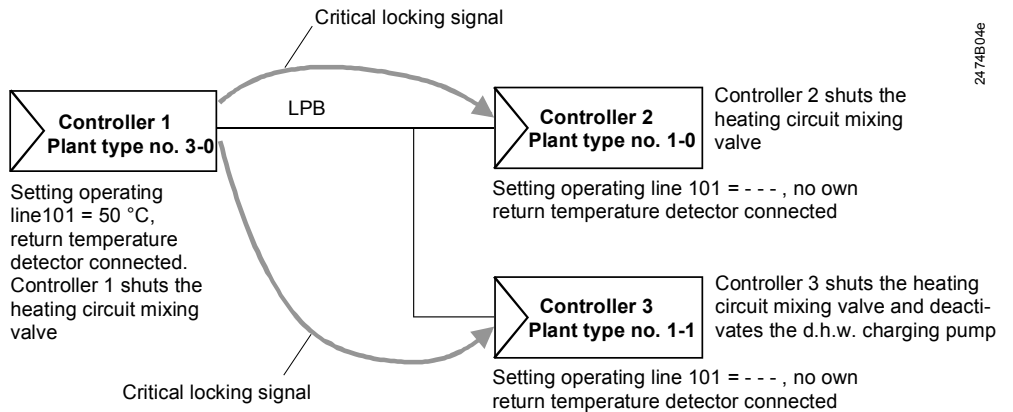

Variant 2 Local impact of limitation

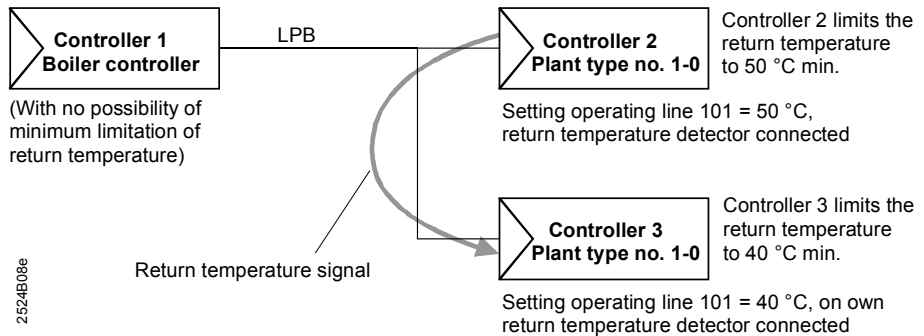

The zone controller with its own return temperature sensor (plant type 1 - x) passes the return temperature to the other zone controllers in the same segment. These can thus ensure minimum limitation of the return temperature locally, depending on the settings made, which means that they generate a critical locking signal internally. For response to critical locking signals, refer to chapter 17.4.6 "Locking signal gain").

13 Function block: District heat

Together with function block "Actuator heating circuit", this function block provides control of the flow temperature in plants with an indirect (heat exchanger) or direct district heat connection.

It acts as a flow temperature controller for weather-compensated control of space heating with a district heat connection (plant type 2 - 0).

If the settings of this function block have been locked (on operating line 248; refer to the respective section), the display shows **OFF** when $\bar{\Delta}$ and $\hat{\Delta}$.

13.1 Operating lines

Line	Function, parameter	Factory setting (range)	Unit
112	Slope, maximum limitation return temperature	0.7 (0.0...4.0)	
113	Start of compensation (point of inflection), maximum limitation return temperature	10 (-50...50)	°C
114	Integral action time, maximum limitation return temperature	30 (0...60)	min

13.2 Limitations

13.2.1 Maximum limitation of primary return temperature

Purpose

For the primary return temperature, maximum limitation is available to ...

- prevent too hot water from being fed back to the district heat network,
- minimize piping losses of the district heat utility,
- comply with the regulations of the utility.

Generation of maximum limit value

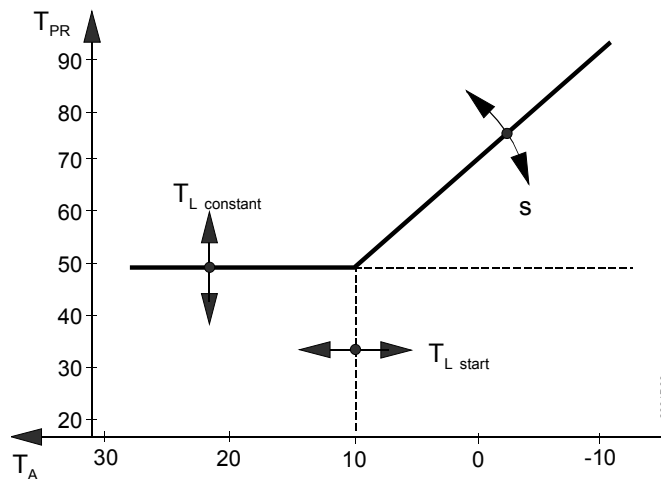

- s Slope of limitation (operating line 112)
- T_A Outside temperature
- $T_{L\ constant}$ Constant value of limitation (operating line 101)
- $T_{L\ start}$ Start of shifting limitation (operating line 113)
- T_{PR} Primary return temperature

The maximum limit value is generated from the following variables:

- Constant value (setting on operating line 101)
- Slope (setting on operating line 112)
- Start of compensation (setting on operating line 113)

The current limit value can be determined as follows:

- If the outside temperature is higher than or equal to the value set for the start of compensation (setting on operating line 113), the current limit value is the constant value entered on operating line 101
- If the outside temperature lies below the value set for the start of compensation, the current limit value T_L is calculated according to the following formula:

$$T_L [^{\circ}\text{C}] = T_{L\text{ constant}} + [(T_{L\text{ start}} - T_A) \cdot s]$$

Function

The outside temperature is the compensating variable used for maximum limitation of the primary return temperature; it can be acquired from the local sensor or via LPB.

Limitation operates according to the selected characteristic:

- When the outside temperature falls, the return temperature is initially limited to the constant value
- If the outside temperature continues to fall, it reaches the set starting point for shifting compensation. From this point, the limit value is raised as the outside temperature falls; the slope of this section of the characteristic can be adjusted

Maximum limitation of the return temperature takes priority over minimum limitation of the flow temperature.

This function can be deactivated via operating line 101.

If the return temperature is limited, the display shows r .

Integral action time

With maximum limitation of the return temperature, the integral action time determines the rate at which the flow temperature setpoint is reduced.

- Short integral action times lead to faster reductions
- Long integral action times lead to slower reductions

With this setting, the impact of the limiting function can be matched to the type of plant.

14 Function block: D.h.w.

This function block is used for making all d.h.w.-related settings.

14.1 Operating lines

Line	Function, parameter	Factory setting (range)	Unit
121*	Assignment of d.h.w.	0 (0...2)	
123	Release of d.h.w. heating	2 (0...2)	
124	D.h.w. priority	0 (0...4)	
126	D.h.w. storage tank sensor/thermostat	0 (0...5)	
127	Boost d.h.w. charging temperature	10 (0...50)	K
128	Switching differential d.h.w.	8 (1...20)	K
129	Maximum time d.h.w. charging	60 (--- / 5...250)	min
130	Setpoint legionella function	--- (--- / 20...100)	°C
131	Forced charging	0 (0 / 1)	

* Operating line 121 is only available with RVP350

14.2 Assignment of d.h.w. heating

Operating line 121 is used to select the heating circuits for which d.h.w. is heated, that is, the heating circuits that draw their water from the same source.

Op. line 121	Comments
0	D.h.w. heating only for heating circuit of own controller
1	D.h.w. is only provided for the heating circuits of the controllers with the same segment number connected to the data bus (LPB)
2	D.h.w. is provided for all heating circuits of the controllers connected to the data bus (LPB)

The setting is required in connection with operating lines 141 (program for the circulating pump) and 123 (release of d.h.w. heating).

14.3 Program for the circulating pump

Refer to chapter 15.2.4 "Circulating pump"

14.4 Frost protection for d.h.w.

Frost protection for the controller's d.h.w. storage tank is ensured by sensor B31 and – if installed – sensor B32.

For the storage tank, a minimum switch-on temperature of 5 °C always applies. If the temperature acquired by sensor B31 or B32 falls below 5 °C, charging is immediately started (independent of other settings), generating a heat request to the precontroller. The switch-off temperature is 5 °C plus the switching differential (set on operating line 128).

Caution!

When using thermostats, frost protection for the d.h.w. storage tank is not provided.

14.5 Release of d.h.w. heating

14.5.1 Function

Operating line 123 is used to select the times at which d.h.w. heating shall be released. Released means that the storage tank is recharged whenever there is a need.

When using this function, d.h.w. heating can be prevented during nonoccupancy times (e.g. at night or during holiday periods).

If, in the summer, d.h.w. charging takes place in alternating mode with an electric immersion heater, the latter is continuously released (24 hours a day) – independent of the setting made on operating line 123.

Mechanism of d.h.w. release:

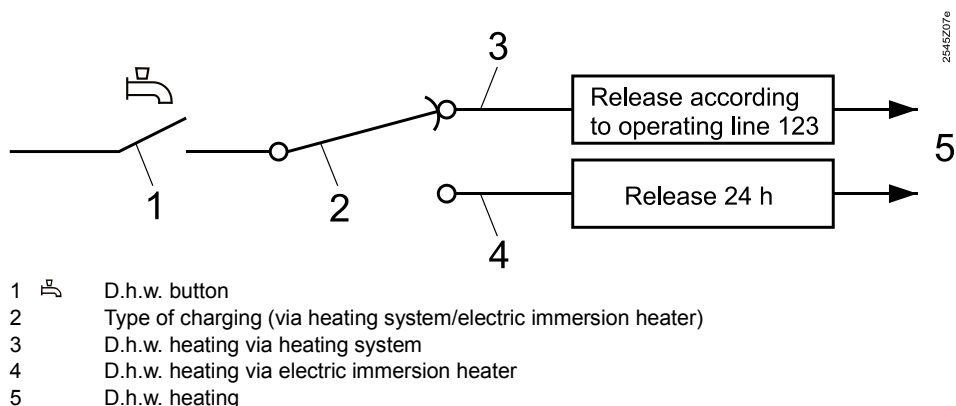

14.5.2 Release programs

Release of d.h.w. heating takes place at the following times, depending on the setting made on operating line 123:





Setting	D.h.w. heating is released ...
0	continuously (24 hours a day)
1	according to one or several heating programs
2	according to scheduler program 2 of own controller

With setting 1, release of d.h.w. heating depends on the setting made on operating line 121. In the case of several heating programs, d.h.w. heating is released if at least one of the controllers involved provides heating to the NORMAL temperature according to its heating program (independent of operating mode) and does not operate in holiday mode.





Release of d.h.w. heating is shifted forward by 1 hour against the times of the heating program. When optimized switching on is active, the optimized switch-on times apply – and not the times entered.

The release of d.h.w. heating is explained on the basis of 2 examples, where controllers A, B, C, and D are interconnected via data bus.

Example 1

<i>Op. line 121</i>	<i>Op. line 123</i>	<i>Con- troller</i>	<i>Oper. mode</i>	<i>Heating program, optimization, holidays</i>	<i>Release</i>
2	1	A	Auto 	06:00...18:00, no opti- mization	D.h.w. heating is released from 04:00 to 23:00
		B		07:00...23:00	
		C	Auto 	07:00...22:00, optimized switching on produces a forward shift of 2 hours	
		D	Auto 	03:00...22:00, holidays	

Example 2

<i>Op. line 121</i>	<i>Op. line 123</i>	<i>Con- troller</i>	<i>Oper. mode</i>	<i>Heating program, optimization, holidays</i>	<i>Release</i>
2	1	A	Auto 	06:00...18:00, no opti- mization	D.h.w. heating is released from 04:00 to 23:00
		B		08:00...23:00	
		C	Auto 	07:00...22:00, optimized switching on produces a forward shift of 2 hours	
		D		05:00...21:00	

14.5.3 D.h.w. heating during holiday periods

In holiday mode, d.h.w. heating is provided as follows:

<i>Op. line 121</i>	<i>Op. line 123</i>	<i>D.h.w. heating</i>
0	0, 1 or 2	No d.h.w. heating when own controller operates in holiday mode
1	0, 1 or 2	No d.h.w. heating when all controllers in the same segment operate in holiday mode
2	0, 1 or 2	No d.h.w. heating when all controllers in the interconnected system operate in holiday mode

14.6 Priority and flow temperature setpoint

14.6.1 Settings

<i>Op. line 124</i>	<i>D.h.w. priority</i>	<i>Flow temperature setpoint according to ...</i>
0	Absolute	d.h.w.
1	Shifting	d.h.w.
2	Shifting	maximum selection
3	None (parallel)	d.h.w.
4	None (parallel)	maximum selection

14.6.2 D.h.w. priority

Depending on the capacity of the heat source, it may be practical to throttle the amount of heat drawn by the heating circuit(s) during d.h.w. heating, thus accelerating the charging process. In that case, d.h.w. heating is given priority to space heating.

For that purpose, the controller offers 3 kinds of d.h.w. priority:

- Absolute priority
- Shifting priority
- No priority (parallel operation)

Priority is accomplished by delivering locking signals. The impact of the locking signals is described in chapter 17.4.6 "Locking signal gain".

14.6.3 Absolute priority

During d.h.w. charging, the heating circuits are locked, which means that they cannot draw any heat.

- Controller without bus connection:
During d.h.w. charging, the controller sends an uncritical locking signal of 100% to its own heating circuit
- Controller with bus connection (not possible with RVP351):
During d.h.w. charging, the controller informs the consumer master that it presently effects d.h.w. charging with absolute priority. The consumer master is the device having the same segment number as the controller with device number 1. The consumer master then sends an uncritical locking signal of 100% to all controllers in the same segment. If the consumer master is located in segment 0, the uncritical locking signal is sent to all controllers in all segments

14.6.4 Shifting priority

During d.h.w. charging, the heating circuits are throttled if the heat source (the boiler) is not able to maintain the required setpoint. In that case, the boiler controller's display shows \downarrow .

- Controller without bus connection:
If, during d.h.w. charging with shifting priority, the boiler is not able to maintain its setpoint, the differential of setpoint and actual value is integrated and an integral-dependent uncritical locking signal in the range of 0...100% is sent to the controller's own heating circuit.
Since shifting priority is determined by the boiler, this kind of priority is only possible with plant type 3 - x. With plant types 1 - x and 2 - x, setting "Shifting priority" has the same impact as setting "No priority"
- Controller with bus connection (not possible with RVP351):
During d.h.w. charging, the controller informs the heat source in the same segment that it currently effects d.h.w. charging with shifting priority. If, now, the boiler is not able to maintain its setpoint, the differential of setpoint and actual value is integrated and an integral-dependent uncritical locking signal in the range of 0...100% is generated. If the heat source is located in segment 0, it sends the signal to all controllers in all segments. If the heat source is located in segment 1...14, it only sends the signal to the controllers in the same segment

14.6.5 No priority

No priority means parallel operation. D.h.w. charging has no impact on the heating circuits.

14.6.6 Flow temperature setpoint

With "Shifting priority" and "No priority", the temperature setpoint for the common flow, which is used for d.h.w. charging **and** space heating, can be generated in 2 different ways:

- Flow temperature setpoint according to maximum selection
- Flow temperature setpoint according to d.h.w. request

With plant types 1 - x and 2 - x, the temperature setpoint for the common flow is forwarded to the precontroller via data bus.

With plant type 3 - x, the temperature setpoint for the common flow is valid for sensor B2.

14.6.7 Maximum selection

With d.h.w. heating, the temperature setpoint for the common flow – which is used for both the d.h.w. and the heating circuit – is generated via maximum selection, based on the 2 heat requests.

Example

The mixing heating circuit calls for 40 °C, the d.h.w. circuit for 65 °C. With d.h.w. charging, the setpoint for the common flow temperature will then be the higher of the 2, namely 65 °C.

14.6.8 D.h.w.

With d.h.w. heating, the temperature setpoint for the common flow used for d.h.w. and the heating circuit will then be that demanded by the d.h.w. circuit.

Example

The mixing heating circuit calls for 80 °C, the d.h.w. circuit for 65 °C. With d.h.w. heating, the temperature setpoint for the common flow will then be that demanded by the d.h.w. circuit, namely 65 °C.

14.7 Type of d.h.w. charging

Refer to chapter 15 "Function block: Multifunctional relays".

14.8 D.h.w. storage tank sensor/thermostat

The way the d.h.w. storage tank temperature is acquired must be selected on operating line 126. It can be captured with 1 or 2 sensors, or with 1 or 2 thermostats.

In the case of plants without solar d.h.w. heating, settings 0 to 3 are available; with solar d.h.w. heating, setting 4 or 5:

Setting	Type of charging
0	D.h.w. charging with 1 sensor
1	D.h.w. charging with 2 sensors
2	D.h.w. charging with 1 thermostat
3	D.h.w. charging with 2 thermostats
4	Solar d.h.w. charging with 1 sensor *
5	Solar d.h.w. charging with 2 sensors *

* The settings for solar d.h.w. charging are to be made on operating lines 201 - 208

The switch-on and switch-off temperatures for charging via sensors are calculated as follows:

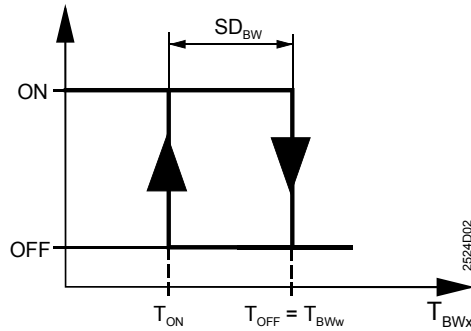

- ON D.h.w. charging ON
- OFF D.h.w. charging OFF
- SD_{BW} Switching differential of d.h.w. charging (operating line 128)
- T_{ON} Switch-on temperature
- T_{OFF} Switch-off temperature
- T_{BWw} NORMAL or REDUCED setpoint of d.h.w. temperature (operating line 26 or 28)
- T_{BWx} D.h.w. temperature (operating line 27)
- T_{BWx1} Measured value storage tank sensor 1 (B31)
- T_{BWx2} Measured value storage tank sensor 2 (B32)

Fixing the switch-on temperature (start of d.h.w. charging):

Op. line 126	Acquisition	Switching criterion
0	1 sensor	$T_{BWx1} < (T_{BWw} - SD_{BW})$
1	2 sensors	$T_{BWx1} < (T_{BWw} - SD_{BW})$ and $T_{BWx2} < (T_{BWw} - SD_{BW})$
2	1 thermostat	Thermostat contact B31 closed
3	2 thermostats	Thermostat contacts B31 and B32 closed
4	Solar via 1 sensor	$T_{BWx1} < (T_{BWw} - SD_{BW})$
5	Solar via 2 sensors	$T_{BWx1} < (T_{BWw} - SD_{BW})$ and $T_{BWx2} < (T_{BWw} - SD_{BW})$

Fixing the switch-off temperature (end of d.h.w. charging):

Op. line 126	Acquisition	Switching criterion
0	1 sensor	$T_{BWx1} > T_{BWw}$
1	2 sensors	$T_{BWx1} > T_{BWw}$ and $T_{BWx2} > T_{BWw}$
2	1 thermostat	Thermostat contact B31 open
3	2 thermostats	Thermostat contacts B31 and B32 open
4	Solar with 1 sensor	$T_{BWx1} > T_{BWw}$
5	Solar with 2 sensors	$T_{BWx1} > T_{BWw}$ and $T_{BWx2} > T_{BWw}$

Note

From the 2 tables above, it is apparent that when using 2 sensors, it is of no importance which is fitted at the top and which at the bottom of the storage tank.

If the storage tank is equipped with a thermostat, it is the thermostat that determines the switch-on/off temperature.

14.9 Boost of d.h.w. charging temperature

Operating line 127 can be used to set the boost of the d.h.w. charging temperature in Kelvin. The boost refers to the d.h.w. temperature setpoint.

The lower the boost setting, the longer d.h.w. charging takes.

$$T_{LW} [^{\circ}\text{C}] = T_{BWW} + T_{BWA}$$

Example:

D.h.w. temperature setpoint (T_{BWW} , operating line 26) = 50 °C

Boost of charging temperature (T_{BWA} , operating line 127) = 10 K

Resulting charging temperature setpoint T_{LW} = 60 °C

If a thermostat is used, the boost of the d.h.w. charging temperature must nevertheless be set.

14.10 Maximum d.h.w. charging time

Operating line 129 can be used to set the maximum charging time for d.h.w. storage tanks. The function is always active, independent of the kind of d.h.w. priority (absolute, shifting, or parallel).

When d.h.w. charging is started, a counter records the charging time. If charging is ended before the set maximum charging time has elapsed, the counter is reset to zero. A new charging cycle can be started any time.

But if charging takes longer than the set maximum time, it is aborted and then locked for the same period of time. Then, charging is resumed, either until the setpoint is reached or until maximum limitation aborts again the charging time.

The function can be deactivated; in that case, the charging time is not limited.

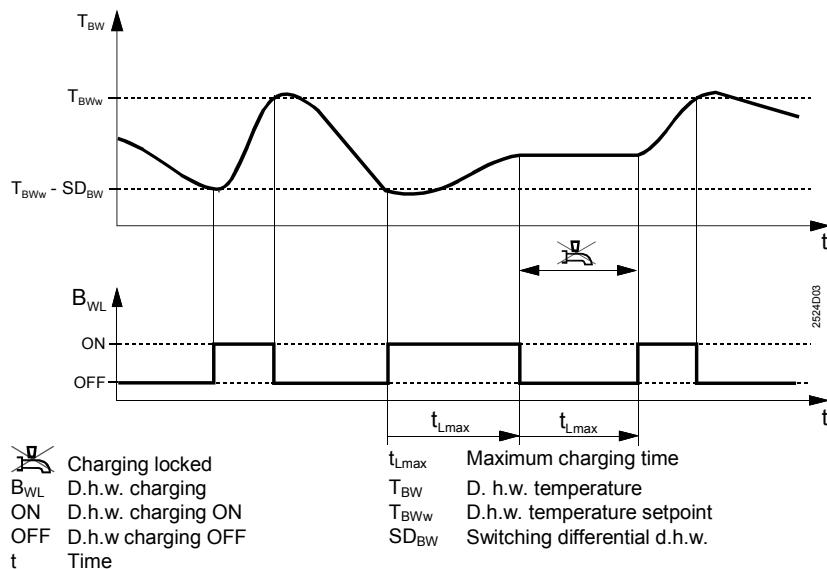

14.11 Setpoint for legionella function

Operating line 130 can be used to adjust the setpoint for the legionella function or to deactivate the function (setting ---).

For a description of the legionella function and related settings, refer to chapter 16 "Function block: Legionella function".

14.12 Forced charging

Operating line 131 can be used to select whether or not forced charging of the storage tank shall take place every day when d.h.w. heating is released for the first time.

With forced charging, the storage tank is also charged when the d.h.w. temperature lies between the switch-on and switch-off temperature. The switch-off point remains the same.

If d.h.w. heating is released for 24 hours a day, forced charging takes place every day at midnight.

14.13 Protection against discharging

14.13.1 Purpose

With plant types that use a d.h.w. storage tank, protection against discharging is ensured during overrun of the d.h.w. charging pump.

This function makes certain that the d.h.w. does not cool down during the time pump overrun is performed.

14.13.2 Mode of operation

With storage tank sensor

If the flow temperature lies below the storage tank temperature, pump overrun is ended prematurely.

The flow temperature is acquired with sensor B2 or obtained via data bus (LPB) as the common flow temperature, depending on the type of plant.

With thermostat

If the flow temperature lies below the d.h.w. temperature setpoint, pump overrun is ended prematurely.

The flow temperature is acquired with sensor B2 or obtained via data bus (LPB) as the common flow temperature, depending on the type of plant.

Flow temperature

The flow temperature is ascertained as follows, depending on the type of plant and the bus connection:

<i>Plant type</i>	<i>Controller without bus connection (LPB)</i>	<i>Controller with bus connection (LPB)</i>
1–1	Since no flow temperature is available, there is no pump overrun due to protection against discharging	Common flow temperature of the same segment via data bus.* Otherwise, there is no pump overrun due to protection against discharging
3–1	Sensor B2	Sensor B2

* Not possible with RVP351 (no LPB)

14.14 Manual d.h.w. charging

D.h.w. charging can be started manually by pressing the d.h.w. button  for 5 seconds. For confirmation, the button flashes for 5 seconds.

Manual d.h.w. charging is also active when ...

- d.h.w. heating is not released,
- the d.h.w. temperature lies inside the switching differential,
- d.h.w. heating is switched off,
- d.h.w. heating is switched off due to the holiday period,
- d.h.w. heating is locked because the maximum charging time has been exceeded.

Manually started charging is aborted only if the d.h.w. temperature setpoint is reached or if the maximum charging time has been exceeded.

After manual charging, d.h.w. heating always remains on, that is, irrespective of whether or not it was off or already on before manual charging was started.

If d.h.w. heating shall be switched off again after manual charging, the button must be pressed again after it flashes (button extinguishes).

Manual charging is not possible when heating the d.h.w. with an electric immersion heater.

15 Function block: Multifunctional relays

The RVP3.. controllers are equipped with up to 2 multifunctional relays K6 and K7 whose functions are selected with this function block. These relays are also used for the control of a circulating pump, a collector pump, or an electric immersion heater for d.h.w. heating. The multifunctional relays can be parameterized independently.

Note

False configurations are not prevented!

15.1 Operating lines

Line	Function, parameter	Factory setting (range)	Unit
141	Function multifunctional relay K6	0 (depending on type of controller)	
142	Function multifunctional relay K7	0 (depending on type of controller)	

The following setting ranges are available, depending on the type of controller, the selected type of plant, and the selected multifunctional relay:

For multifunctional relay K6

Controller type	Plant type	Setting range
RVP340	x - 0	0..2
RVP350	x - 0	0..2
	x - 1	0..9
RVP351	x - 0	0..2
	x - 1	0..7

For multifunctional relay K7

Controller type	Plant type	Setting range
RVP350	x - 1	0..4
RVP351	x - 1	0..2

15.2 Functions of multifunctional relays K6/K7

The multifunctional relays can be assigned the following functions:

Operating line		Function
141 (K6)	142 (K7)	
0	0	No function
1	-	Relay energized in the event of fault
2	-	Relay energized when there is demand for heat
3	-	Circulating pump continuously ON (24 hours a day)
4	-	Circulating pump ON according to heating program(s) (depending on the setting made on operating line 121)
5	-	Circulating pump ON according to scheduler program 2
6	1	Collector pump
7	2	Switching over d.h.w. heating "Heating/electric" according to own controller
8*	3*	Switching over d.h.w. heating "Heating/electric" according to all controllers having the same segment number in the interconnected system
9*	4*	Switching over d.h.w. heating "Heating/electric" according to all controllers in the interconnected system

* Not possible with RVP351

In the case of plant types without d.h.w. heating (x - 0), the only settings that can be made are the following:

- "Relay energized in the event of fault"
- "Relay energized when there is demand for heat"

15.2.1 No function

The multifunctional relay is not assigned any function.

15.2.2 Relay energized in the event of fault

If the controller receives an error message from itself or via data bus (LCD shows **Er**), the multifunctional relay is energized. This takes place with a delay of 2 minutes. When the error is corrected, that is, when the error message is no longer present, the relay is deenergized with no delay.

15.2.3 Relay energized when there is heat demand

If the controller's own heating circuit or the d.h.w. circuit calls for heat, the multifunctional relay is energized.

In interconnected plants, the relay is also energized when the controller receives a demand for heat from the system.

15.2.4 Circulating pump

General mode of operation

Operating line 141 can be used to enter the scheduler program according to which the d.h.w. circulating pump shall operate. The use of a circulating pump is optional with all types of plant.

The circulating pump runs only when d.h.w. heating is on (button  is lit).

The circulating pump runs at the following times, depending on the setting made on operating line 141:





Op. line 141	Circulating pump runs ...
3	continuously (24 hours a day)
4	according to one or several heating programs
5	according to scheduler program 2 of own controller

With setting 4, operation of the circulating pump depends on the setting made on operating line 121 (provided the controller has communication capability and operates in an interconnected plant). In an interconnected plant with several controllers, that is, with several heating programs, the circulating pump runs when at least one of the controllers involved provides heating to the NORMAL temperature according to its heating program (independent of operating mode) and does not operate in holiday mode.





The circulating pump operates with a forward shift against the times of the heating program; this means that optimized switching on has an impact.

The behavior of the circulating pump is shown on the basis of 2 examples where controllers A, B, C, and D are interconnected via data bus (not possible with RVP351):

Example 1

Op. line 121	Op. line 141	Con- troller	Operating mode	Heating program, holidays	Circulating pump
2	4	A	Auto 	06:00...18:00	Circulating pump runs from 06:00 to 23:00
		B		07:00...23:00	
		C	Auto 	07:00...22:00	
		D	Auto 	03:00...22:00, holi- days	

Example 2

Op. line 121	Op. line 141	Con- troller	Operating mode	Heating program, holidays	Circulating pump
2	4	A	Auto 	06:00...18:00, opti- mized switching on produces a forward shift of 2 hours	Circulating pump runs from 4:00 to 23:00
		B		08:00...23:00	
		C	Auto 	07:00...22:00	
		D		05:00...21:00	

Operation of circulating pump during holiday periods

In holiday mode, the circulating pump runs according to the setting made, as shown in the following table:

Op. line 121	Op. line 141	Operation of circulating pump
0	3, 4 or 5	Circulating pump OFF when own controller operates in holiday mode
1	3, 4 or 5	Circulating pump OFF when all controllers in the same segment operate in holiday mode
2	3, 4 or 5	Circulating pump OFF when all controllers in the intercon- nected system operate in holiday mode

15.2.5 Collector pump

The multifunctional relay is used to control the collector pump.

Activation of the collector pump is dependent on the temperatures acquired in the storage tank and the collector.

Op. line		Function
141	142	
6	1	Collector pump

The storage tank sensor(s) used is (are) selected via operating line 126.

The settings required for solar d.h.w. charging must be made via operating lines 201 – 208.

15.2.6 Type of d.h.w. charging

The type of d.h.w. charging must be entered on operating line 141 or 142.

Basically, 2 choices are available:

- Charging via the heating system, or
- Charging in alternating mode via the heating system or with the electric immersion heater.

Note

The setting has no impact on solar d.h.w. charging.

This is put into operation, independently of this setting, provided the respective switch-on criteria are satisfied.

Charging via the heating system

The setting to be made on operating line 141 is 0...5, and the setting on operating line 142 is 0 or 1.

The d.h.w. storage tank is charged via the heating system throughout the year.

Charging in alternating mode

The setting to be made on operating line 141 is 7, 8 or 9, or on operating line 142 it is 2, 3 or 4.

In the winter, the d.h.w. storage tank is charged via the heating system, and in the summer with the electric immersion heater.

Switching over takes place according to the following criteria:

- Switching from charging via the heating system to the electric immersion heater takes place when there is no demand for space heating for at least 48 hours (switching over at midnight)
- Switching from the electric immersion heater to charging via the heating system is effected when there is heat request from space heating. Depending on the setting made on operating line 141 (7, 8 or 9), different types of heat requests are considered for the switchover criterion:

<i>Op. line</i>		<i>Function</i>
141	142	
7	2	Heat request from the controller's own heating circuit
8*	3*	Heat requests from all controllers having the same segment number and being connected to the data bus (LPB), including those from the controller's own heating circuit
9*	4*	Heat requests from all controllers connected to the data bus (LPB), including those from the controller's own heating circuit

* Not possible with RVP351

16 Function block: Legionella function

When using d.h.w. heating systems with storage tanks, the legionella function prevents excessive concentrations of legionella viruses. The function ensures periodic heating up of the d.h.w. to a sufficiently high temperature level for a certain dwelling time.

16.1 Operating lines

<i>Line</i>	<i>Function, parameter</i>	<i>Factory setting (range)</i>	<i>Unit</i>
147	Periodicity of legionella function	1 (0...7)	-
148	Starting point legionella function	05:00 (00:00...23:50)	hh:mm
149	Dwelling time at legionella setpoint	30 (0...360)	min
150	Circulating pump operates during the legionella function	1 (0 / 1)	-

16.1.1 Setpoint/switching on/off

"Setpoint legionella function" is to be adjusted via function block "D.h.w." on operating line 130. Setting --- deactivates the legionella function.

16.1.2 Periodicity of legionella function

Operating line 147 can be used to select the periodicity of the legionella function:

- When using setting 0, the d.h.w. temperature is raised to the legionella setpoint on a daily basis
- When using setting 1 to 7, the d.h.w. temperature is raised to the legionella setpoint on a weekly basis. Setting 1 raises the d.h.w. temperature every Monday, setting 2 every Tuesday, etc.

16.1.3 Starting point

The time of day the legionella function shall be started can be set on operating line 148.

16.1.4 Dwelling time at legionella setpoint

Operating line 149 is used to define for what period of time the actual value of the d.h.w. temperature must lie above the legionella setpoint (operating line 130) for the function to be considered fulfilled.

16.1.5 Operation of circulating pump

Operating line 150 is used to select whether the legionella function shall act on the d.h.w. circulating pump:

- With setting 0, the legionella function does not act on the circulating pump.
- With setting 1, the legionella function acts on the circulating pump.

16.2 Mode of operation

Preconditions for the legionella function:

- The storage tank temperature is acquired with sensor(s) (legionella function not possible with thermostats)
- The legionella function was activated by defining a setpoint (operating line 130).
- D.h.w. heating is on (button  lit)
- Holiday function and operating mode changeover via contact H1 are not active
- Charging is effected via the heating system and not with the electric immersion heater

If the criteria of periodicity and starting time are fulfilled, the legionella function is released. Release of the legionella function means that the d.h.w. temperature setpoint is raised to the level of the legionella setpoint and that forced charging is triggered.

If d.h.w. heating is off, or the holiday function or operating mode changeover is active, the legionella function is released, but not the setpoint boost. On completion of the overriding function, d.h.w. charging to the legionella setpoint is started since release of the legionella function is maintained.

The following graph shows the behavior of the legionella function as a function of the d.h.w. temperature:

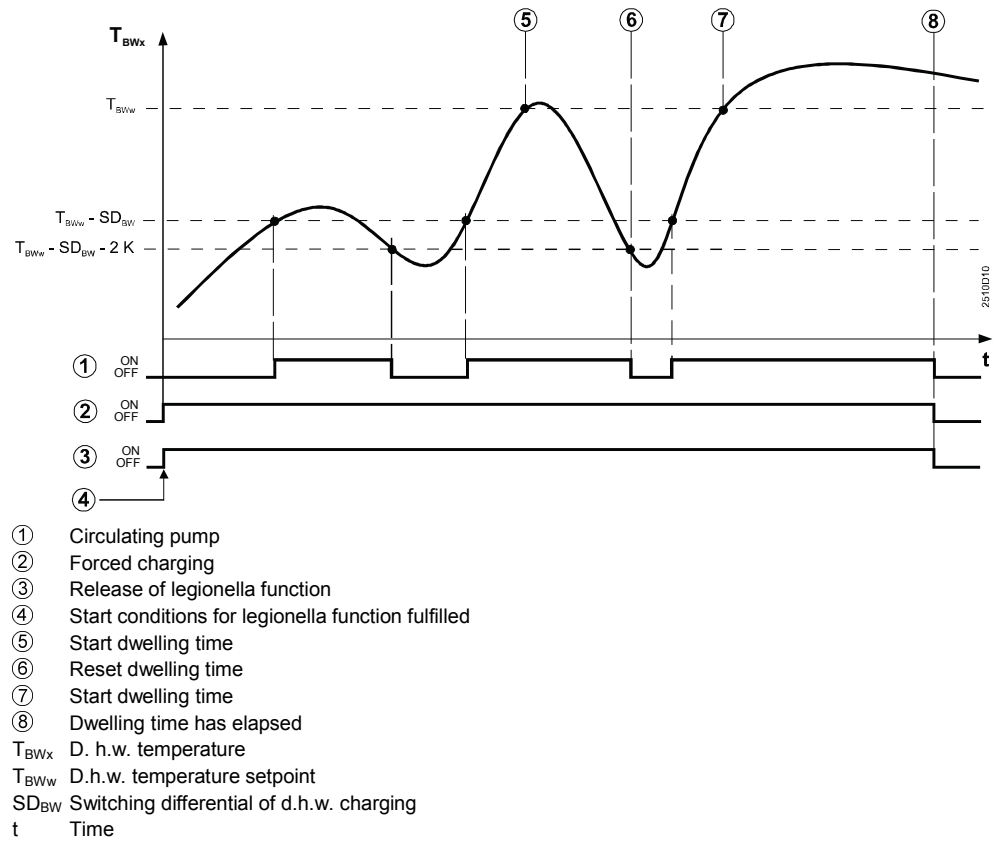

It set, a maximum d.h.w. charging time is also active here. If the legionella setpoint is not reached, the legionella function is interrupted to be resumed on completion of the maximum charging time.

The maximum d.h.w. temperature setpoint has no impact on the legionella setpoint.

17 Function block: Service functions and general settings

This function block is used to combine various displays and setting functions that are of assistance in connection with commissioning and service work. In addition, a number of extra functions are performed.

The number of available operating lines and settings depend on the type of controller used.

17.1 Operating lines

<i>Line</i>	<i>Function, parameter</i>	<i>Factory setting (range)</i>	<i>Unit</i>
161	Simulation of outside temperature	--.- (--.- / -50...50)	°C
162	Relay test	RVP340: 0 (0...5) RVP35...: 0 (0...10)	
163	Sensor test	Display function	
164	Display of setpoint	Display function	
167	Outside temperature for frost protection for the plant	2.0 (--.- / 0...25)	°C
168	Flow temperature setpoint for frost protection for the plant	15 (0...140)	°C
169*	Device number	0 (0...16)	
170*	Segment number	0 (0...14)	
172	Operating mode when terminals H1–M are bridged	Plant type x - 0: 0 (0...3) Plant type x - 1: 0 (0...9)	
173	Locking signal gain	100 (0...200)	%
174	Pump overrun time	6 (0...40)	min
175	Pump kick	0 (0/1)	
176	Changeover winter-/summertime	25.03 (01.01. ... 31.12)	
177	Changeover summer-/wintertime	25.10 (01.01. ... 31.12)	
178*	Clock mode	0 (0...3)	
179*	Bus power supply, operating mode and status indication	A (0 / 1 / A)	
180*	Outside temperature source	A (A / 00.01... 14.16)	
194	Hours run counter	Display function	
195	Software version	Display function	

* Not available with RVP351

17.2 Display functions

17.2.1 Hours run counter

The number of controller operating hours are displayed. The controller counts the hours whenever operating voltage is present.

The reading is limited to a maximum of 500,000 hours (57 years).

17.2.2 Software version

The display shows the software version currently used by the controller.

17.3 Commissioning aids

17.3.1 Simulation of outside temperature

To facilitate commissioning and fault tracing, outside temperatures in the range from -50 to 50 °C can be simulated. Simulation has an impact on the current, the composite and the attenuated outside temperature.

Simulated T_A = current T_A = composite T_A = attenuated T_A

During the simulation, the current outside temperature (as acquired by the sensor or via LPB) is overridden.

When simulation is completed, the current outside temperature gradually readjusts the composite and the attenuated outside temperature to their correct values. Hence, simulation of the outside temperature leads to a reset of the attenuated and the composite outside temperature.

Simulation can be ended in one of 3 different ways:

- By entering --.-
- By leaving the setting level by pressing any of the operating mode buttons
- Automatically after 30 minutes

17.3.2 Relay test

The output relays can be individually energized. The following codings apply, depending on the type of controller and type of plant:

RVP340:

<i>Input</i>	<i>Relay test</i>	<i>Relay</i>
0	Normal operation (no test)	–
1	All relays deenergized	–
2	Actuator heating circuit OPEN	Y1
3	Actuator heating circuit CLOSE	Y2
4	Heating circuit pump ON	Q2
5	Multifunctional relay K6 energized	K6

RVP35..

<i>Input</i>	<i>Relay test</i>	<i>Relay</i>
0	Normal operation (no test)	–
1	All relays deenergized	–
2	Burner stage 1 ON	K4
3	Burner stages 1 and 2 ON	K4 and K5
4	Heating circuit pump ON	Q1
5	Storage tank charging pump ON	Q3
6	Actuator heating circuit OPEN	Y1
7	Actuator heating circuit CLOSE	Y2
8	Heating circuit pump ON	Q2
9	Multifunctional relay K7 energized	K7
10	Multifunctional relay K6 energized	K6

The relay test can be ended in one of 4 different ways:

- By entering 0 on the operating line
- By leaving the setting level by pressing \triangle or ∇
- By leaving the setting level by pressing any of the operating mode buttons
- Automatically after 30 minutes

17.3.3 Sensor test

Operating line 163 can be used to check the connected sensors; if available, the current setpoints and limit values are displayed on operating line 164.

The 8 temperatures can be queried by entering 0...8:

Input	Op. line 163 (actual values)	Op. line 164 (setpoints)
0	Actual value of outside sensor at terminal B9. If the outside temperature is obtained via data bus, the display shows ---	No display
1	Actual value of flow temperature sensor at terminal B1	Flow temperature setpoint. If there is no heat request, the display shows ---
2	Actual value of room temperature sensor at terminal B5	Room temperature setpoint
3	Actual value of room unit at terminal A6	Room temperature setpoint
4	Actual value of return sensor at terminal B7. If the return temperature is obtained via data bus, the display shows ---	Limit value of return temperature. If there is no return temperature limitation, the display shows ---
5*	Actual value of storage tank sensor at terminal B31	D.h.w. temperature setpoint
6*	Actual value of storage tank sensor at terminal B32	D.h.w. temperature setpoint
7*	Actual value of collector sensor at terminal B6	Setpoint of collector sensor (corresponds to actual value of storage tank sensor B32 plus temperature differential solar ON on operating line 201)
8*	Actual value of boiler sensor at terminal B2	Boiler temperature setpoint (switch-off point). If there is no heat request, the display shows ---

* Not available with RVP340

Errors in the measuring circuits are displayed as follows:

000 = short-circuit (thermostat: contact closed)
- - - = interruption (thermostat: contact open)

When changing from operating line 163 to 164, or vice versa, the selected sensor (setting 0...8) is maintained.

17.4 Auxiliary functions

17.4.1 Frost protection for the plant

The plant can be protected against frost. Precondition is that controller and heat source are ready to operate (mains voltage present!).

The following settings are required:

- Outside temperature at which frost protection shall respond
- Minimum flow temperature to be maintained by the frost protection function

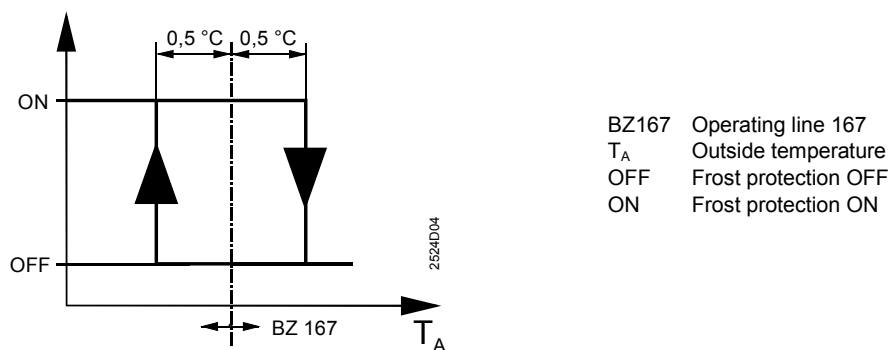

If the current outside temperature falls below the limit value (setting on operating line 167 minus 0.5 °C), the controller switches heating circuit pump M2 on and maintains the flow temperature at the setpoint selected for frost protection (operating line 168).

An appropriate heat request is sent to the heat source.











The control is switched off when the outside temperature exceeds the limit value by 0.5 °C.

Frost protection for the plant can be deactivated (setting --- on operating line 167).

17.4.2 Manual overriding of operating mode (contact H1)

Using a simple remote control, the operating mode of the heating circuit and that of d.h.w. can be overridden. This is accomplished by bridging terminals H1–M.

The operating mode that shall rule when H1–M are bridged can be selected on operating line 172:

Setting		Operating mode of heating circuit	Operating mode of d.h.w. circuit
0		Protection mode	OFF
1	Auto 	AUTO	OFF
2		REDUCED	OFF
3		NORMAL	OFF
4		Protection mode	ON
5	Auto 	AUTO	ON
6		REDUCED	ON
7		NORMAL	ON
8	Auto 	AUTO	ON (24 hours a day)
9		NORMAL	ON (24 hours a day)

In the case of controllers without d.h.w. heating (plant types x - 0), 0...3 are the only possible settings.

As long as this function is active, the LED of the respective operating mode button flashes at a low frequency (approx. 0.5 Hz). The buttons themselves are inoperable however.

When the function is deactivated, the controller resumes the previously selected operating mode.

17.4.3 Pump overrun

To prevent heat from building up, a common pump overrun time can be set on operating line 174 for all pumps associated with the controller (with the exception of the circulating pump). So, upon deactivation, the pumps continue to run for the set overrun time.

D.h.w. discharging protection has priority over the pump overrun function.

In interconnected plants, the set time also affects the forced signals that a boiler can deliver to ensure overtemperature protection.

For more detailed information, refer to chapter 11.4.5 "Protection against boiler overtemperatures".

17.4.4 Pump kick

To prevent pump seizing during longer off periods (e.g. in the summer), a periodic pump kick can be activated on operating line 175. The input is either 0 or 1:

0 = no periodic pump kick

1 = weekly pump kick

If the pump kick is activated, all pumps run for 30 seconds, one after the other, every Friday morning at 10:00, independent of all other functions and settings.

17.4.5 Winter-/summertime changeover

Changeover from wintertime to summertime, and vice versa, takes place automatically. If international regulations change, the dates need to be reentered. The date to be entered is the earliest possible changeover date. Changeover always takes place on a Sunday.

Example

If the start of summertime is specified as the "Last Sunday in March", the earliest possible changeover date is March 25. Then, the date to be entered on operating line 176 is 25.03.

If no winter-/summertime changeover is required, the 2 dates must be set so that they coincide.

17.4.6 Locking signal gain

Basics

Functions "Maintained boiler return temperature", "Protective boiler startup" and "D.h.w. priority" use locking signals that are forwarded to the heat exchangers and consumers. With the heat exchanger and consumer controllers, operating line 173 (locking signal gain) can be used to set how intensely these controllers shall respond to locking signals. The locking signal gain is adjustable from 0% to 200%.

Setting	Response
0%	Locking signal is ignored
100%	Locking signal is adopted on a 1-to-1 basis
200%	Locking signal is adopted as a double signal

There are 2 types of locking signals:

- Uncritical locking signals
- Critical locking signals

The response of the consumers depends on the type of load.

Uncritical locking signals

Uncritical locking signals are generated in connection with d.h.w. priority (absolute and shifting) and only act on the heating circuits.

The response of the heating circuit depends on the type of heating circuit:

- Heating circuit with mixing valve/2-port valve:
In the heating circuit, the flow temperature setpoint is reduced as a function of the set locking signal gain. The mixing valve/2-port valve closes, the heating circuit pump continues to run
- Heating circuit with pump:
When the uncritical locking signal reaches a defined value, the heating circuit pump is deactivated, independent of the set locking signal gain. In plants using a diverting valve, the valve is driven to the d.h.w. position

Critical locking signals

Critical locking signals are generated by the boiler temperature controller during protective boiler startup and during minimum limitation of the boiler return temperature. If the boiler temperature controller is located in segment 0, the critical locking signal is sent to all consumers and heat exchangers in the bus network and – if present – to its own heating and d.h.w. circuit. If the boiler temperature controller is located in segment 1... 14, it only delivers the critical locking signal to all loads in the same segment and – if present – to its own heating and d.h.w. circuit.

Minimum limitation of the return temperature can also be ensured locally by a controller with plant type 1 - x. In that case, the critical locking signal only acts inside the controller and is only delivered to the controller's own heating circuit and the d.h.w. circuit.

With regard to the response of the consumers and heat exchangers, there are 2 choices:

- Heat exchangers and consumers with mixing valve/2-port valve:
The flow temperature setpoint is reduced as a function of the set locking signal gain. Heat exchangers and consumers close their mixing valve/2-port valve
- Consumers with pump circuit:
When the critical locking signal reaches a defined value, the pump is deactivated, independent of the set locking signal gain. In plants using a diverting valve, the valve is driven to the heating circuit position

17.5 Inputs for LPB (RVP340 and RVP350)

17.5.1 Source of time of day

Several sources are available for the time of day, depending on the master clock. The source must be entered on the controller on operating line 178 (clock mode), using setting 0...3:

- 0 = autonomous clock in the controller
- 1 = time of day via bus; clock (slave) without remote readjustment
- 2 = time of day via bus; clock (slave) with remote readjustment
- 3 = time of day via bus; central clock (master)

The impact of the individual inputs is as follows:

Input	Impact	Diagram
0	<ul style="list-style-type: none"> • Time of day on the controller can be readjusted • Time of day of controller is not matched to the system time 	
1	<ul style="list-style-type: none"> • Time of day on the controller cannot be readjusted • Time of day of controller is continuously and automatically matched to the system time 	
2	<ul style="list-style-type: none"> • Time of day on the controller can be readjusted and, at the same time, re-adjusts the system time since the change is adopted by the master • Time of day on the controller is nevertheless automatically and continuously matched to the system time 	
3	<ul style="list-style-type: none"> • Time of day on the controller can be readjusted and, at the same time, re-adjusts the system time • Time of day on the controller is used for the system 	

t ch Manual readjustment of time of day on the controller
t N Controller time
t sys System time

Per system, only 1 controller may be used as a master. If several controllers are parameterized as masters, an error message is delivered (error code 100).

17.5.2 Outside temperature source

If, in interconnected plants, the outside temperature is acquired via bus, the temperature source can be addressed either automatically or directly (operating line 180).

Addressing	Display, input	Comments
Automatically	A xx.yy	Display A (for automatically) and xx.yy (address of automatically selected source): xx = segment number, yy = device number)
Directly	xx.yy	Source address must be entered

If the controller operates autonomously (without bus), there is no display and inputs cannot be made.

If the controller is used in an interconnected plant **and** it has its own outside sensor, it is not possible to enter an address (if an entry is made, the display shows OFF). In that case, the controller always acquires the outside temperature from its own sensor. The address displayed is the controller's own.

For detailed information about addressing the source, refer to Data Sheet N2030.

17.5.3 Addressing the devices

Every device connected to the data bus (LPB) requires an address. This address is made up of a device number (1...16, operating line 169) and a segment number (0...14, operating line 170).

In an interconnected plant, every address may be assigned only once. If this is not observed, the correct functioning of the entire connected plant cannot be ensured. In that case, an error message is delivered (error code 82).

If the controller operates autonomously (without bus), the device number must be set to zero.

Since the device address is also associated with control processes, it is not possible to use all possible device addresses in all types of plant:

Plant type	G = 0 S = any (no bus)	G = 1 S = 0	G = 1 S = 1...14	G = 2...16 S = any
1 - x	Permitted	Permitted	Permitted	Permitted
2 - x	Permitted	Permitted	Permitted	Permitted
3 - x	Permitted	Permitted	Permitted	Not permitted

G = device number
S = segment number

If an inadmissible address has been entered for the selected plant type, an error message appears (error code 140).

For detailed information about addressing devices, refer to Data Sheet N2030.

17.5.4 Bus power supply

In interconnected plants with a maximum of 16 controllers, bus power supply can be decentralized, that is, power can be supplied by each connected device. If a plant contains more than 16 devices, central bus power supply is mandatory.

In that case, it must be selected on every connected device whether the data bus is powered centrally or decentrally by the controllers.

With the controller, this setting is made on operating line 179. The display shows the selection made on the left and the current bus power supply state on the right.

<i>Display</i>	<i>Bus power supply</i>
0	Central bus power supply is mandatory (no power supply via controller)
A	Decentral bus power supply via controller
	0 No bus power supply presently available
	1 Bus power supply presently available

BUS appears on the display only when a bus address is valid and bus power supply is available. Hence, the display indicates whether or not data traffic via data bus is possible.

17.5.5 Bus loading number

The bus loading number E of the RVP3.. for the LPB is as follows:

RVP340 = 6

RVP350 = 7

RVP351 ⇒ no LPB

The sum of all bus loading numbers E of all devices connected to the same bus must not exceed 300.

18 Function block: Solar d.h.w.

18.1 Operating lines

This function block provides settings for the heating engineer.

Line	Function, parameter	Factory setting (range)	Unit
201	Temperature differential solar ON	8 (0...40)	K
202	Temperature differential solar OFF	4 (0...40)	K
203	Frost protection temperature for collector	--- (--- / -20...5)	°C
204	Overtemperature protection for collector	105 (--- / 30...240)	°C
205	Evaporation temperature of heat conducting medium	140 (--- / 60...240)	°C
206	Maximum limitation of charging temperature	80 (8...100)	°C
207	Maximum limitation storage tank temperature	90 (8...100)	°C
208	Collector start function gradient	--- (--- / 1...20)	min/K

18.2 General

In the case of plant types equipped with a d.h.w. storage tank, the RVP35.. supports solar d.h.w. heating.

The function is activated ...

- when function "D.h.w. storage tank sensor" (operating line 126, setting 4 "Solar d.h.w. heating with one sensor" or setting 5 "Solar d.h.w. heating with two sensors") is parameterized, **and**
- when 1 of the 2 multifunctional relays K6 or K7 is parameterized for use with the collector pump (operating line 141, setting 6, or operating line 142, setting 1).

Then, solar d.h.w. charging is always released. It is performed via the collector pump based on the temperature differential of d.h.w storage tank and collector.

Solar charging control uses storage tank sensor B32 at the bottom.

If that sensor is not installed, storage tank sensor B31 at the top (if installed) is automatically used.

During the time the solar circuit charges the storage tank, the display shows ☀.

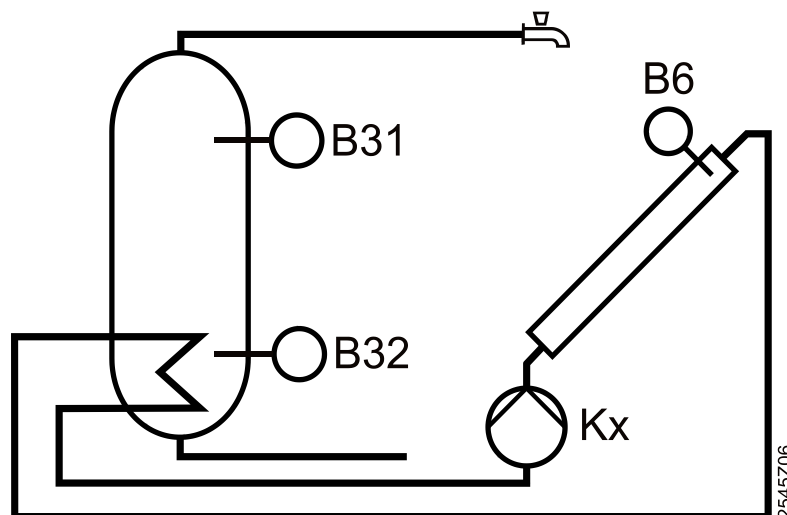

- B31 Storage tank sensor 1
- B32 Storage tank sensor 2
- B6 Collector sensor
- Kx Collector pump connected to K6 or K7

18.3 Functions

18.3.1 Temperature differential ON/OFF solar

Operating lines 201 and 202 are used to set the temperature differential for switching solar d.h.w. charging on and off.

A certain temperature differential of collector and storage tank is required for charging; also, the collector must have reached the minimum charging temperature.

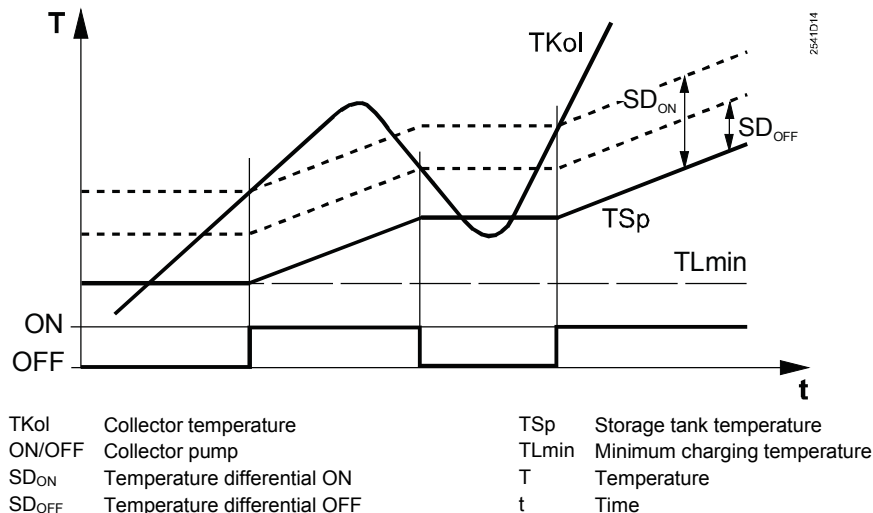

- The storage tank is charged when the collector temperature exceeds the current storage tank temperature by the switch-on differential:
 $TKol > TSp + SD_{ON}$
- Storage tank charging is stopped when the collector temperature drops below the switch-off differential:
 $TKol < TSp + SD_{OFF}$

18.3.2 Minimum charging temperature

The collector pump is only activated when the collector reaches a minimum temperature of 30 °C and when the required temperature differential is attained.

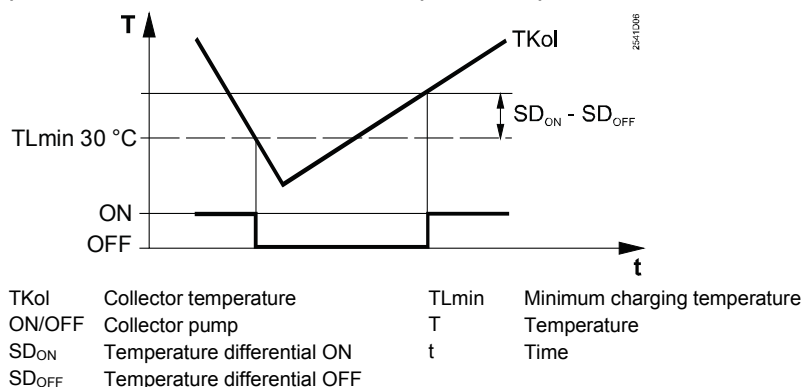

- Charging is aborted when the collector temperature drops below the minimum charging temperature (even if the switch-on differential is reached):
 $TKol < TLmin$
- Charging is effected when the collector temperature exceeds the minimum charging temperature by the switching differential ($SD_{ON} - SD_{OFF}$) (and when the required switch-on differential is reached):
 $TKol > TLmin + (SD_{ON} - SD_{OFF})$

18.3.3 Minimum running time

When the collector pump is activated, it keeps running for a minimum time of t_{Min} = 20 seconds. This minimum on time applies to all functions that activate the collector pump.

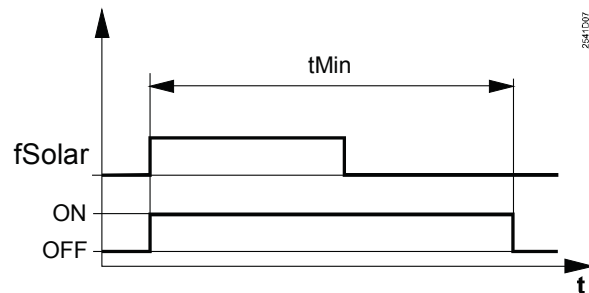

fSolar Solar function
ON/OFF Collector pump
tMin Minimum on time

Frost protection as a special case

To ensure that the flow pipe from the collector to the storage tank is flushed with hot water, deactivation of the collector pump after reaching the frost protection limit at the collector sensor is delayed by the minimum running time.

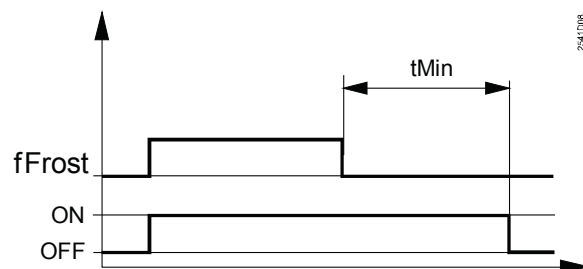

fFROST Frost protection function solar
ON/OFF Collector pump
tMin Minimum running time

18.3.4 Frost protection temperature for the collector

Operating line 203 is used to set the frost protection temperature for the collector. If there is risk of frost at the collector, the collector pump is activated to prevent the heat conducting medium from freezing.

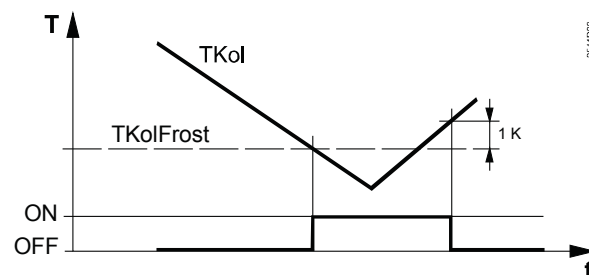

TKol Collector temperature
TKolFrost Frost protection temperature for collector
ON/OFF Collector pump
T Temperature
t Time

- The collector pump is activated when the collector temperature drops below the frost protection temperature: $TKol < TKolFrost$
- The collector pump is deactivated when the collector temperature rises 1 K above the frost protection temperature: $TKol > TKolFrost + 1 K$

- The frost protection function is aborted when the d.h.w. storage tank temperature drops below 8 °C
- Setting --- deactivates the frost protection function for the collector

18.3.5 Overtemperature protection for the collector

Operating line 204 is used to set the temperature that protects the collector against overheating.

If there is a risk of collector overtemperature, storage tank charging is continued beyond maximum limitation of the charging temperature (setting on operating line 206) until maximum limitation of the storage tank temperature is reached (setting on operating line 207), aimed at reducing the amount of surplus heat.

When maximum limitation of the storage tank temperature is reached, overtemperature protection for the collector is no longer possible, and the collector pump is deactivated.

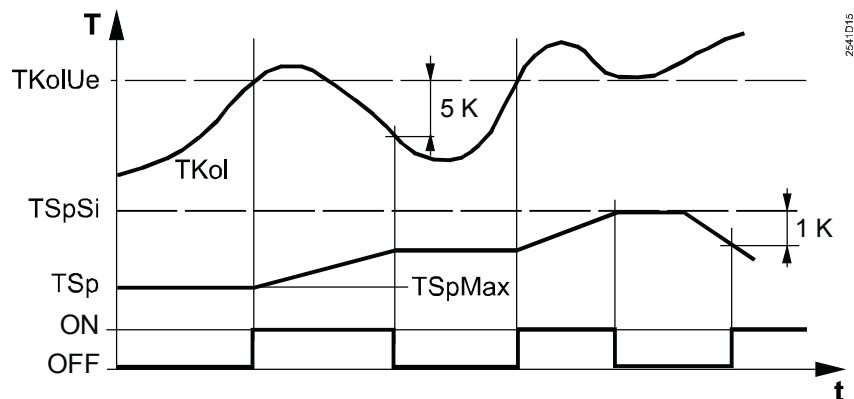

TSpSi	Maximum limitation of storage tank temperature
TSp	Storage tank temperature
TKoIUe	Overtemperature protection for collector
TSpMax	Maximum limitation of charging temperature
TKol	Collector temperature
ON/OFF	Collector pump
T	Temperature
t	Time

- If the collector temperature exceeds the overtemperature protection level and maximum limitation of the storage tank temperature is not yet reached, the collector pump is activated: $TKol > TKoIUe$ and $TSp < TSpSi$.
If the collector temperature drops 5 K below the overtemperature protection level, the collector pump is deactivated: $TKol < TKoIUe - 5 K$
- If the storage tank temperature rises to the maximum limit value, the collector pump is deactivated:
 $TSp > TSpSi$
If the storage tank temperature drops 1 K below maximum limitation of the d.h.w. storage tank temperature, the collector pump is activated again:
 $TSp < TSpSi - 1 K$

If 2 storage tank sensors are used, the sensor acquiring the highest temperature is considered.

Setting --- deactivates overtemperature protection for the collector.

18.3.6 Storage tank recooling

After overtemperature protection for the collector has been active, function "Storage tank recooling" discharges the d.h.w. storage tank to bring it down to a lower temperature level.

Storage tank recooling is effected via the collector's surface. For that, the collector pump is activated, thus transferring heat from the storage tank to the collector to be emitted to the environment via the collector's surface.

The recooling setpoint (TRk) is set to a fixed 80 °C. The switching differential for recooling (SD_{ON}) corresponds to the value of the switch-on differential (operating line 201) of charging control, but is limited to a minimum of 3 K for recooling.

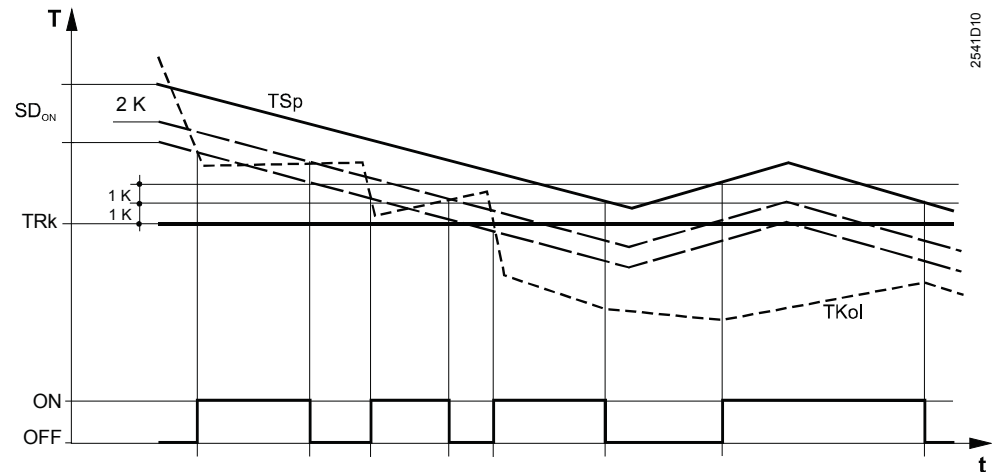

SD _{ON}	Temperature differential ON	ON / OFF	Collector pump
TRk	Recooling setpoint	T	Temperature
TSp	Storage tank temperature	t	Time
TKol	Collector temperature		

- If the storage tank temperature lies at least 2 K above the recooling setpoint and by at least the temperature differential ON above the collector temperature, the collector pump is activated:
 $TSp > TRk + 2\text{ K}$ and $TSp > TKol + SD_{ON}$
- If the collector temperature rises to a level of 2 K below the storage tank temperature, the collector pump is deactivated:
 $TKol > TSp - 2\text{ K}$
- If the storage tank temperature reaches a level of 1 K above the recooling setpoint, the function is ended:
 $TSp < TRk + 1\text{ K}$

18.3.7 Evaporation temperature of heat conducting medium

Operating line 205 is used to set the evaporation temperature of the heat conducting medium. If there is a risk of evaporation of the heat conducting medium (due to high collector temperatures), the collector pump is deactivated to prevent it from overheating. This is a pump protection function.

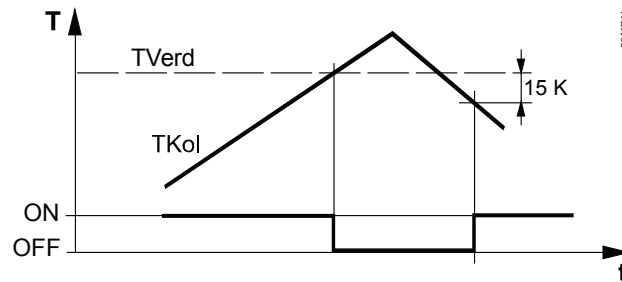

T_{Verd} Evaporation temperature of heat conducting medium
 T_{Kol} Collector temperature
 ON/OFF Collector pump
 T Temperature
 t Time

- The collector pump is deactivated if the collector temperature exceeds the evaporation temperature:
 $T_{Kol} > T_{Verd}$
- The collector pump is activated again when the collector temperature drops 15 K below the evaporation temperature:
 $T_{Kol} < T_{Verd} - 15 \text{ K}$

Setting --- deactivates the pump protection function.

Evaporation protection of the heat conducting medium (pump off) has priority over overtemperature protection which would activate the pump.

18.3.8 Maximum limitation of charging temperature

Operating line 206 is used to set the maximum limitation for the charging temperature. When the maximum charging temperature in the storage tank is reached, the collector pump is deactivated.

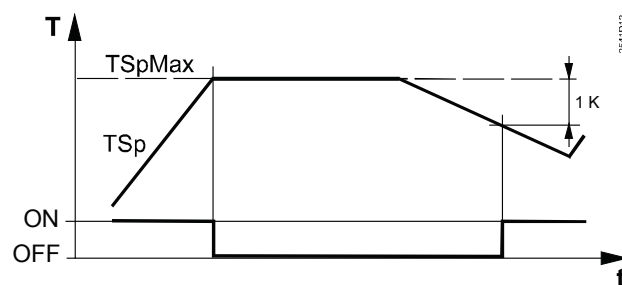

T_{Sp} Storage tank temperature
 T_{SpMax} Maximum lim value of charging temperature
 ON/OFF Collector pump
 T Temperature
 t Time

- Charging is aborted if the storage tank temperature exceeds the maximum limit value:
 $T_{Sp} > T_{SpMax}$
- Charging is released again when the storage tank temperature drops 1 K below the maximum limit value:
 $T_{Sp} < T_{SpMax} - 1 \text{ K}$

Note

Overtemperature protection for the collector can again activate the collector pump until the storage tank temperature reaches its maximum limit value.

18.3.9 Maximum limitation of storage tank temperature

Operating line 207 is used to set the maximum limitation of the storage tank temperature.

The storage tank is never charged to a level above the set maximum temperature (refer to chapter 18.3.5 "Overtemperature protection for the collector").

Caution

Maximum limitation of the storage tank temperature is not a safety function!

18.3.10 Collector start function

The controller is supplied with the collector start function deactivated.

Since the temperature at the collector (especially in the case of vacuum pipes) cannot be reliably acquired when the pump is not running, the pump can be activated based on an adjustable gradient [min/K].

Operating line 208 is used to set the gradient for the collector start function.

The gradient corresponds to the temperature increase per minute when the collector is off:

- Gradient = 1 [min/K]: Corresponding to a temperature increase of 1 [K/min]
- Gradient = 20 [min/K]: Corresponding to a temperature increase of 1/20 [K/min]

If, within 1 minute, the temperature acquired by the collector sensor rises more than the set gradient, the pump is activated (minimum running time 20 seconds). If the required collector charging temperature is reached within the period of time the pump runs, solar d.h.w. charging is started and the pump remains activated.

If the collector temperature does not reach the required level, or drops again, the pump is again deactivated. The pump remains on for a maximum of 1 minute plus the minimum running time (20 seconds), if the solar charging function does not provide control of the pump.

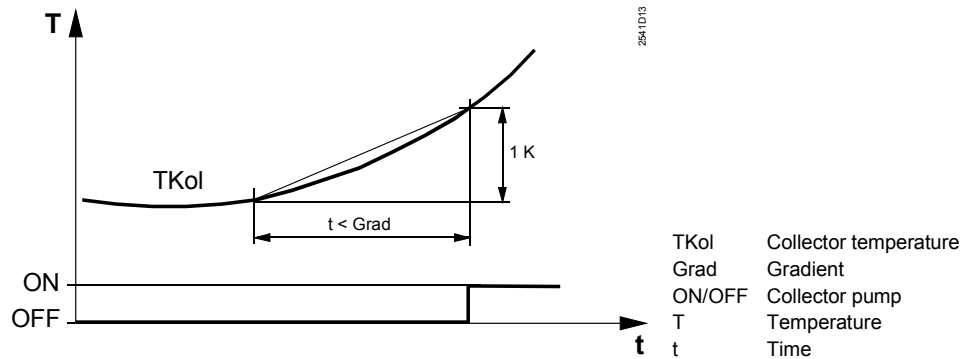

Setting --- deactivates the collector start function.

19 Function block: Locking functions

All settings can be locked on the software side to prevent tampering.

19.1 Operating line

<i>Line</i>	<i>Function, parameter</i>	<i>Factory setting (range)</i>	<i>Unit</i>
248	Locking of settings	RVP340: 0 (0...2) RVP35...: 0 (0 / 1)	-







19.2 Locking settings on the software side

Operating line 248 can be used to lock on the software side the settings made on the controller. This means that the settings made can still be queried on the controller, but cannot be changed anymore. Locking can include:

- All settings
- Only the settings required in connection with the district heat parameters (only RVP340)

The settings can be changed via bus (RVP340 and RVP350).

The procedure is as follows:

1. Press  and  simultaneously until **LoD** appears on the display.
2. Press , ,  and , one after the other.
3. Now, operating line 248 appears on the display. The following locking choices are available:
 - 0 = no locking
 - 1 = all settings are locked
 - 2 = only the settings required for the district heat are locked (operating lines 101 to 114)

After locking all settings, the following operating elements remain active:

- The buttons for selecting the operating lines

No longer active are ...

- the buttons for making readjustments of values,
- the knob for making readjustments of the room temperature,
- the operating mode buttons (only for leaving the setting level),
- the button for manual control.

20 Communication

20.1 Interplay with room units

20.1.1 General

The room temperature acquired by a room unit is fed to controller terminal A6. If the room temperature signal delivered by the room unit shall not be included in the control functions, the respective source must be selected (operating line 65). In that case, the other room unit functions are maintained.

- The controller detects the connection of an inadmissible room unit and identifies it as an error for display on operating line 50 (error code 62)
- Errors the room unit detects in itself are displayed by the controller on operating line 50 (error code 61)

20.1.2 Interplay with room unit QAA50.110/101

General

The QAA50.110/101 can act on the controller as follows:

- Overriding the heating circuit's operating mode
- Readjustment of room temperature

For that purpose, the QAA50.110/101 has 3 operating elements:

- Operating mode selector
- Economy button (also termed presence button)
- Knob for room temperature readjustments







Overriding the heating circuit's operating mode

From the QAA50.110/101, the operating mode of the heating circuit can be overridden. This is accomplished via the operating mode selector and the economy button.

To enable the room unit to act on the controller, the latter must satisfy the following operating conditions:

- Heating circuit operating mode AUTO
- No holiday period active, no manual control

The operating mode selector of the QAA acts on the controller as follows:

Operating mode of QAA50.110/101	Operating mode of heating circuit controller
	Auto  ; optional temporary overriding with economy button
	Continuously NORMAL  or continuously REDUCED  heating, depending on the economy button
	Protection mode 

Knob for room temperature readjustments

With the knob of the QAA50.110/101 the room temperature setpoint for NORMAL heating can be readjusted by ± 3 °C.

The QAA50.110/101 does not affect adjustment of the room temperature setpoint on the controller's operating line 1.

20.1.3 Interplay with room unit QAW70

In combination with the QAW70, the following functions can be performed, or the room unit can act on the controller as follows:

- Overriding the heating circuit's operating mode
- Changing room temperature setpoints
- Changing the d.h.w. temperature setpoint
- Readjustment of room temperature
- Input of time of day
- Overriding the heating program
- Display of the actual values acquired by the controller

For this purpose, the QAW70 has the following operating elements:

- Operating mode button
- Economy button (also termed presence button)
- Knob for readjusting the room temperature
- Buttons for selecting the operating lines
- Buttons for readjusting values







Overriding the heating circuit's operating mode

From the QAW70, the heating circuit's operating mode can be overridden. This is accomplished via the operating mode selector and the economy button.

To enable the room unit to act on the controller, the latter must satisfy the following operating conditions:

- Heating circuit operating mode AUTO
- No holiday period active, no manual control

The operating mode selector of the QAW70 acts on the controller as follows:

Operating mode of QAW70	Operating mode of heating circuit controller
 AUTO	Auto  ; optional temporary overriding with economy button
	Continuously NORMAL  or continuously REDUCED  heating, depending on the economy button
	Protection mode 

Knob for room temperature readjustments

With the knob of the QAW70, the room temperature setpoint for NORMAL heating can be readjusted by ± 3 °C.

The QAW70 does not affect the adjustment of the room temperature setpoint on the controller's operating line 1.

Overriding the QAW70 inputs from the controller

If the controller with a connected QAW70 is isolated from the mains network and then reconnected, the following parameters on the QAW70 will be overwritten with the settings made on the controller:

- Time of day and weekday
- Complete heating program
- Room temperature setpoint for NORMAL heating
- Room temperature setpoint for REDUCED heating
- D.h.w. temperature setpoint

Hence, the controller is always the data master.

Impact of the individual QAW70 operating lines on the controller

If 1 (slave without remote control) is entered on the controller's operating line 178 ("Source of time of day"), the time of day on the QAW70 cannot be readjusted.

Op. line QAW70	Function, parameter	Impact on controller, notes
1	Setpoint for NORMAL heating	Changes controller operating line 1
2	Setpoint for REDUCED heating	Changes controller operating line 2
3	D.h.w. temperature setpoint	Changes controller operating line 26 with plant types providing d.h.w. heating
4	Weekday (entry of heating program)	Corresponds to controller operating line 4
5	1st heating phase, start of NORMAL heating	Changes controller operating line 5
6	1st heating phase, end of NORMAL heating	Changes controller operating line 6
7	2nd heating phase, start of NORMAL heating	Changes controller operating line 7
8	2nd heating phase, end of NORMAL heating	Changes controller operating line 8
9	3rd heating phase, start of NORMAL heating	Changes controller operating line 9
10	3rd heating phase, end of NORMAL heating	Changes controller operating line 10
11	Display of weekdays 1...7	Cannot be changed (refer to chapter 7.3 "Time of day and date")
12	Entry of time of day	Changes controller operating line 38
13	Display of d.h.w. temperature	Only with plant types providing d.h.w. heating
14	Display of boiler temperature	(Only with plant type 3 - x)
15	Display of flow temperature	
16	Holidays	Controller switches to protection mode
17	Reset to default values	QAW70 default entries apply
51	Bus address	When using RVP340 or RVP35.., the bus address to be entered on the room unit is 1
52	Identification of room unit	
53	Operating lock on QAW70	No impact on the controller
58	Type of setpoint display	No impact on the controller

20.1.4 Interplay with SYNERGYR central unit OZW30

Based on the room temperature of the individual apartments, the OZW30 central unit (software version 3.0 or higher) generates a load compensation signal. This signal is passed on via LPB to the controller where it leads to an appropriate change of the flow temperature setpoint.

20.2 Communication with other devices

RVP340 and RVP350 offer the following communication choices:

- Forwarding the heat demand of several RVP3... to the heat source
- Exchange of locking and forced signals
- Exchange of measured values, such as outside temperature, return temperature and flow temperature, plus clock signals
- Communication with other devices
- Exchange of error messages

For detailed information about communication via LPB, refer to the following pieces of documentation:

- Data Sheet N2030: LPB Basic System Data
- Data Sheet N2032: LPB Basic Engineering Data

21 Handling

21.1 Operation

21.1.1 General

Operating elements

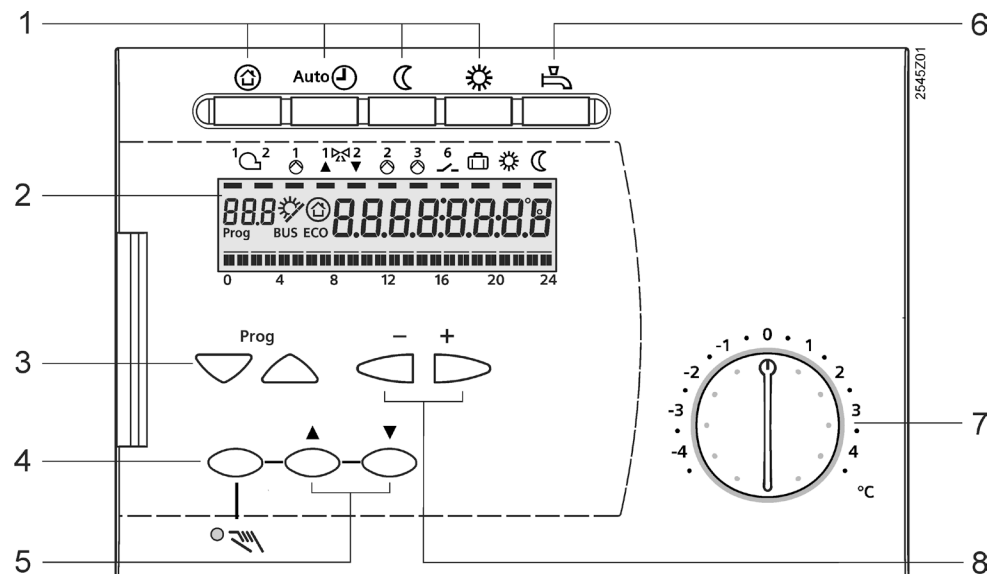

- 1 Buttons for selecting the operating mode (button pressed is lit)
- 2 Display (LCD, RVP35...-specific)
- 3 Buttons for selecting the operating lines
- 4 Button for manual control ON/OFF
- 5 Buttons for valve OPEN/CLOSE when manual control ON
- 6 Button for d.h.w. heating ON/OFF (ON = button lit)
(only with RVP35..)
- 7 Knob for readjusting the room temperature
- 8 Buttons for adjusting values

LCD and status display RVP3..

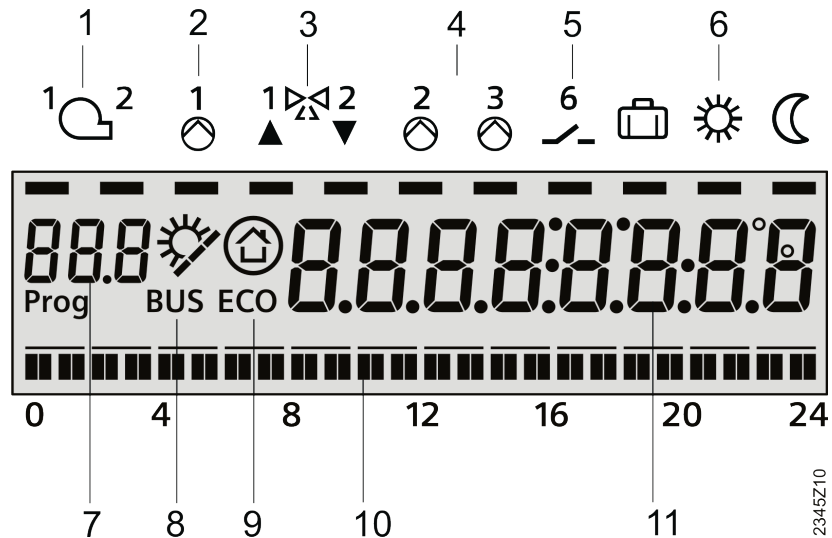

Display (LCD)

- 1* Burner operation stage 1 and stage 2
 - 2* Operation of circulating pump M1
 - 3 Positioning signals to the actuator
Bar below number 1 lit = actuator receives OPEN pulses
Bar below number 2 lit = actuator receives CLOSE pulses
 - 4 Operation of heating circuit pump M2 and storage tank charging pump M3*
Example: Bar below number 2 lit = pump M2 runs
 - 5 State of multifunctional relay K6
Example: Bar below symbol lit = relay energized
 - 6 Current temperature level (nominal temperature/reduced temperature/holiday period)
Example: Bar below ☼ lit = heating to REDUCED temperature
 - 7 Number of current operating line
 - 8 Bus power supply ** available and active charging of d.h.w. storage tank by the solar circuit*
 - 9 Display of "ECO function active" or "Protection mode active"
 - 10 Display of current heating program
 - 11 Display of temperatures, times, dates, etc.
- * Not available with RVP340
** Not available with RVP351

Operating Instructions

Operating Instructions are inserted at the rear of the controller's front cover. They are provided for caretakers and end-users and contain energy saving tips including instructions on troubleshooting.

21.1.2 Operating elements

Buttons for heating circuit operating mode

4 buttons are available for selection of the heating circuit's operating mode. Each button has a built-in LED; the currently active operating mode is indicated by the respective LED when lit.

D.h.w. button

A button is available for switching d.h.w. heating on and off. When pressing the button, d.h.w. heating is switched on or off. The button is lit when d.h.w. heating is ON.

Knob for room temperature readjustments

Manual d.h.w. charging is triggered by pressing the same button.

A knob is available for making manual room temperature readjustments. Its scale shows the room temperature change in °C. When turning the knob, the heating curve is displaced parallel.

Buttons and displays for manual control

3 buttons are provided for manual control:

- 1 button for activating manual control. An LED indicates when manual control is active. Manual control is quit by pressing the same button again or by pressing any of the operating mode buttons
- 2 buttons for manual positioning commands. In plants with mixing valves or 2-port valves, the actuating device can be driven to any position by pressing the respective button.

When pressing a button, the respective LED lights up

Display of positioning commands

All positioning commands sent to the relays appear on the LCD.

Operating line principle

Input and readjustment of all setting parameters, activation of functions and reading of actual values and operating states are based on the operating line principle. An operating line with an associated number is assigned to each parameter, each actual value and each function.

A pair of buttons is used to select operating lines and readjust displays.

Buttons

To select and readjust setting values, the procedure is as follows:

Buttons	Action	Effect
Line selection buttons	Press ▾	Selection of next lower operating line
	Press ▴	Selection of next higher operating line
Setting buttons	Press ◀	Decrease of displayed value
	Press ▶	Increase of displayed value

The set value is adopted ...

- when selecting the next operating line,
- by pressing any of the operating mode buttons.

If input of --.- or --:-- is required, button ◀ or ▶ must be pressed until the required display appears. Then, the display maintains --.- or --:--.

Block skip function

The operating lines are combined in the form of blocks. To reach a specific operating line of a function block quickly, the other blocks can be skipped, so that it is not necessary to go through all the other lines. This is made possible by using 2 button combinations:

Action	Effect
Keep ▾ depressed and press ▶	Selection of next higher function block
Keep ▾ depressed and press ◀	Selection of next lower function block

Info values

Basic information about the plant is obtained by pressing $\bar{\triangleleft}$ and $\bar{\triangleright}$.
Meaning:

Number	Plant information
---	Time of day
0	Outside temperature B9
1	Flow temperature
2	Room temperature
3	Return temperature
4*	D.h.w. temperature B31
5*	D.h.w. temperature B32
6*	Collector temperature B6
7*	Boiler temperature B2

* Not available with RVP340

The information selected last is continuously displayed.

21.1.3 Setting levels and access rights

Setting levels

The operating lines are assigned to different levels. Assignment and access are as follows:

Level	Op. lines	Access
Enduser	1 to 50	Press \triangleup or \triangledown
Heating engineer	51 to 208	Press \triangledown and \triangleup simultaneously for 3 seconds
Locking level	248	Press \triangledown and \triangleup simultaneously until \bar{Lod} appears; then, press \triangledown , \triangleup , $\bar{\triangleleft}$ and $\bar{\triangleright}$, one after the other

Access rights

- The end-user can access all analog operating elements. This means that he can select the operating mode, readjust the room temperature with the knob, and activate manual control. Also, he is allowed to access operating lines 1 through 50
- The heating engineer can access all operating elements and all operating lines

21.2 Commissioning

21.2.1 Installation Instructions

The controller is supplied complete with Installation Instructions covering in detail installation, wiring and commissioning with function checks and settings. The instructions address trained specialists. Each operating line has an empty field where the set value can be entered.

The Installation Instructions together with the plant's documentation should be kept in a safe place!

21.2.2 Operating lines

Selecting operating line "Plant type"

The most important task when a plant is commissioned is to enter the required type of plant. This input activates all functions and settings required for the selected type of plant.

Setting the other operating lines

All operating lines contain proven and practice-oriented values. The Installation Instructions show codings and give guide values, comments, etc., where required.

Operating lines for function checks

Function block "Service functions" contains 4 operating lines that are especially suited for making function checks:

- Operating line 161 permits simulation of the outside temperature
- Operating line 162 can be used to energize any of the output relays
- Operating line 163 can be used to query any of the actual values of sensors
- Operating line 164 can be used to query any of the sensor setpoints or limit values

If **Er** appears on the display, the error can be pinpointed via the error code on operating line 50.

21.3 Installation

21.3.1 Mounting location

The ideal location for the controller is a dry room, such as the boiler room.

The permissible ambient temperature is 0...50 °C.

When the mounting location is selected, the controller can be fitted as follows:

- In a control panel, on an inner wall or on a top hat rail
- On a panel front
- In a control panel front
- In the sloping front of a control desk

21.3.2 Mounting choices

The controller can be mounted in one of 3 different ways:

- Wall mounting: The base is secured to a flat wall with 3 screws
- Rail mounting: The base is snapped on a top hat rail
- Flush-panel mounting: The base is fitted in a panel cutout measuring 138 x 92 mm. The thickness of the front panel may be 3 mm maximum

21.3.3 Electrical installation

- Local electrical safety regulations must be complied with
- The electrical installation must be made by qualified personnel
- The cable lengths should be chosen such that there is sufficient space to open the control panel door
- Cable strain relief must be ensured
- The cable glands used must be made of plastic
- The cables of the measuring circuits carry extra low-voltage
- The cables from the controller to the actuating devices and pumps carry mains voltage
- Sensor cables must not be run parallel to mains carrying cables
- A defective or apparently damaged unit must immediately be disconnected from power

22 Engineering

22.1 Connection terminals

RVP340

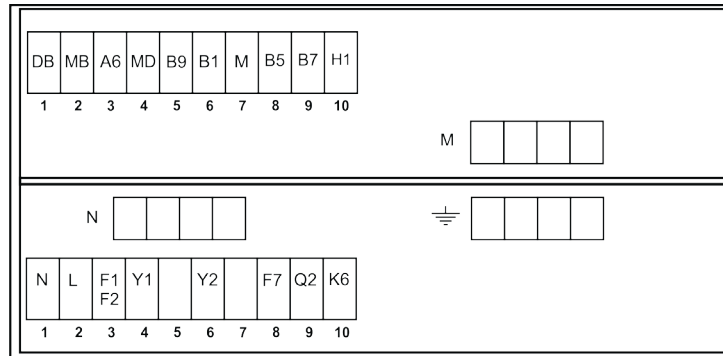

RVP350

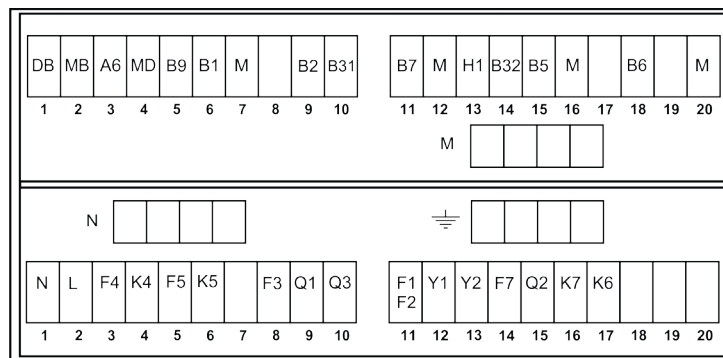

RVP351

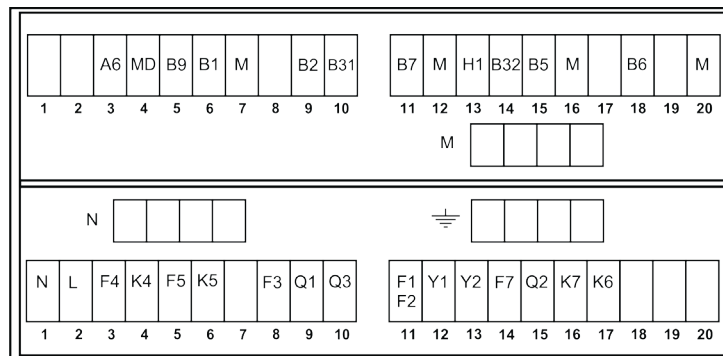

Low-voltage side

DB	Data LPB
MB	Ground for LPB
A6	PPS (point-to-point interface), connection of room unit
MD	Ground for PPS
B9	Outside sensor
B1	Flow sensor
M	Ground for sensors and changeover contacts
B31	Storage tank sensor/thermostat at the top
B32	Storage tank sensor/thermostat at the bottom
B7	Return sensor
H1	Changeover contact "Operating mode"
B5	Room sensor
B6	Collector sensor

In addition to the standard connection terminals, auxiliary terminals for M are provided

Mains voltage side

N	Neutral conductor AC 230 V
L	Live AC 230 V
F4	Input for K4
K4	1. burner stage
F5	Input for K5
K5	2. burner stage
F3	Input for Q1 and Q3
Q1	Circulating pump
Q3	Storage tank charging pump
F1/F2	Input for Y1 and Y2
Y1	Heating circuit mixing valve/2-port valve OPEN
Y2	Heating circuit mixing valve/2-port valve CLOSE
F7	Input for Q2, K6, and K7
Q2	Heating circuit pump
K6	Multifunctional relay
K7	Multifunctional relay

In addition to the standard connection terminals, auxiliary terminals for N and \perp are provided

22.2 Connection diagrams

22.2.1 Low-voltage side

RVP340

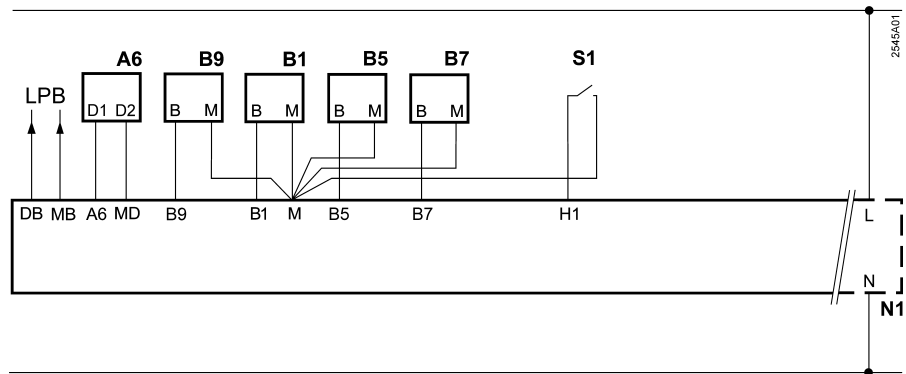

RVP350 and RVP351

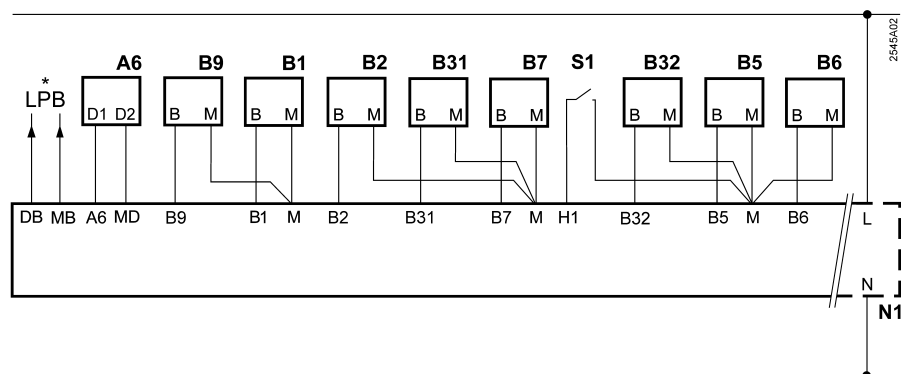

* LPB only with RVP350

22.2.2 Mains voltage side

RVP340

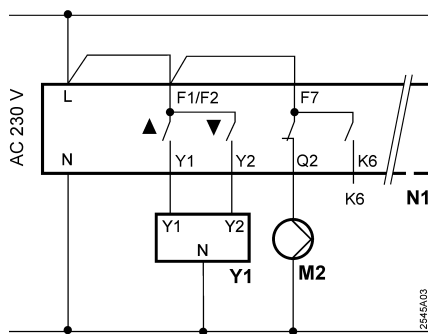

RVP350 and RVP351

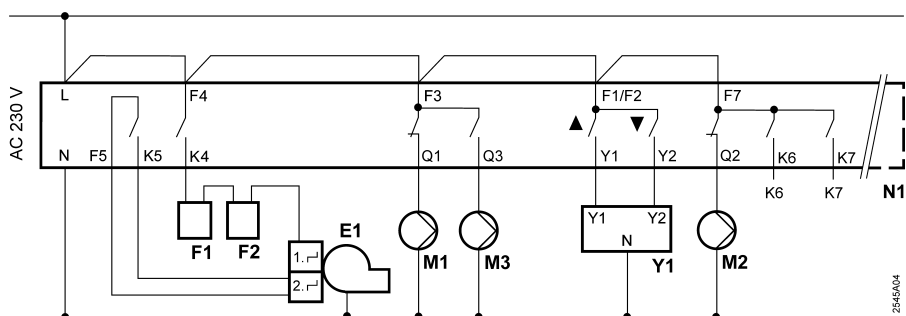

Key

A6	Room unit
B1	Flow sensor
B2	Boiler sensor (only RVP35..)
B31	D.h.w. storage tank sensor/thermostat (only RVP35..)
B32	D.h.w. storage tank sensor/thermostat (only RVP35..)
B5	Room sensor
B6	Collector sensor (only RVP35..)
B7	Return sensor
B9	Outside sensor
E1	2-stage burner (only RVP35..)
F1	Thermal reset limit thermostat (only RVP35..)
F2	Safety limit thermostat (only RVP35..)
Kx	K6, K7 = multifunctional outputs
LPB	Data bus (only RVP340 and RVP350)
M1	Circulating pump (only RVP35..)
M2	Heating circuit pump
M3	Storage tank charging pump (only RVP35..)
N1	Controller RVP3...
S1	Remote control of operating mode
Y1	Actuator heating circuit

23 Mechanical design

23.1 Basic design

The RVP3.. controller consists of controller insert, which accommodates the electronics, the power section, the output relays and – on the front – all operating elements, and the base, which carries the connection terminals. On the inner side of the cover, there is a holder where the Operating Instructions can be inserted.

The controller has the standard overall dimensions 96 mm x 144 mm.

It can be mounted in one of 3 different ways:

- Wall mounting
- Mounting on a top hat rail
- Flush-panel mounting

Whichever mounting method is chosen, the base must always be mounted and wired first. To ensure orientation will be correct, the upper side of both the base and the controller housing carry the marking TOP. Both the top and the bottom side of the base have 5 knockout holes for cable entry; there are 10 knockout holes in the floor.

The controller insert plugs into the base. The controller insert has 2 fixing screws with rotating levers. If, after insertion of the controller insert, one of the screws is tightened, the lever engages in an opening in the base. When the screws are further tightened (alternately), the controller pulls itself into the base so that it is secured.

23.2 Dimensions

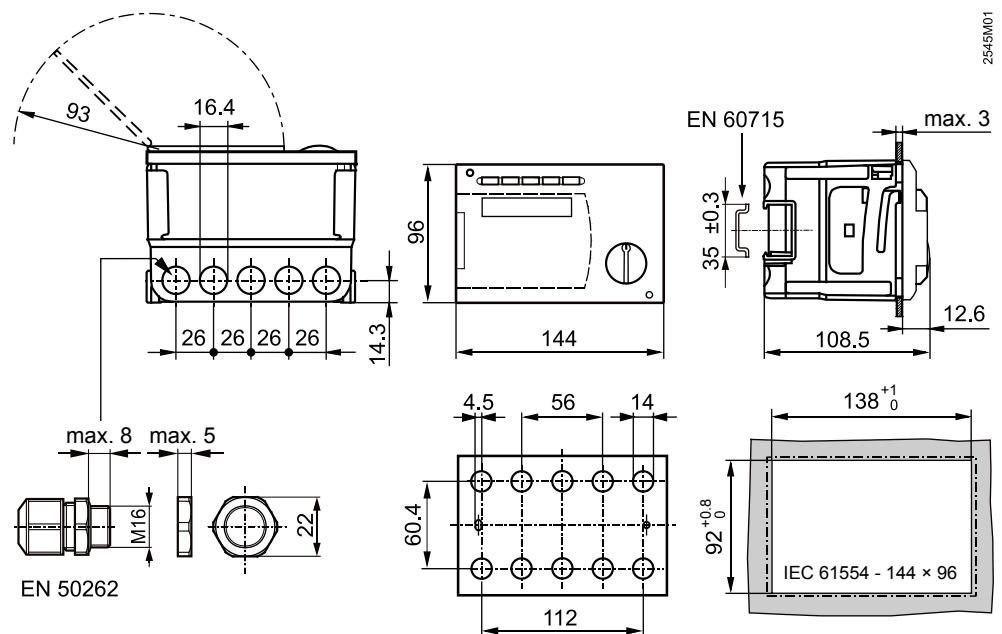

Dimensions in mm

25-45M01

24 Addendum

24.1 Technical data

For technical data, refer to Data Sheet N2545.

24.2 Revision history

Edition 1.0 is the first publication of this document. So there are no alterations against any previous editions.

Index

2

- 2-position control 43, 46
- 2-position controller 45

3

- 3-position control 44

A

- Absolute priority 59
- Access rights 97
- Acknowledgement 28
- Acquisition of measured values 19
- Addressing QAA50.110/101 90
- Addressing the devices 80
- Alternating mode 68
- Analog operating elements 95
- Assignment of d.h.w. heating 56
- Attenuated outside temperature 31
- Automatic ECO function 30
- Auxiliary terminals 100
- Averaging 19

B

- B31 21
- B32 21
- B6 22
- B7 21
- B9 20
- Base 103
- Basic heating curve settings 38
- Block skip function 96
- Boiler operating mode 45
- Boiler temperature 20
- Boost heating 36
- Boost of d.h.w. charging temperature 62
- Building time constant 30
- Burner cycling protection 46
- Burner running time 46
- Bus loading number 81
- Bus power supply 81
- Buttons for heating circuit operating mode 95
- Buttons for manual control 95

C

- Central unit OZW30 93
- Charging temp. solar maximum limitation 87
- Circulating pump 66
- Collector off temperature 88
- Collector pump 67, 84
- Collector sensor 22
- Collector start function 88
- Collector temperature 83

- Combinations 14
- Commissioning 98
- Commissioning aids 73
- Communication 93
- Compensating and auxiliary variables 30
- Composite outside temperature 30
- Connection terminals 100
- Contact H1 76
- Control with 1-stage burner 46
- Control with 2-stage burner 47
- Controller insert 103
- Critical locking signals 78
- Current outside temperature 30

D

- D.h.w. 56
- D.h.w. actual value 26
- D.h.w. button 95
- D.h.w. charging 67
- D.h.w. heating modes 17
- D.h.w. NORMAL setpoint 25
- D.h.w. REDUCED setpoint 25
- Deflection of heating curve 39
- Digital operating elements 96
- Dimensions 103
- Direct burner control 45
- Display of errors 28
- Documentation 10
- Dwelling time (legionella function) 69

E

- Early shutdown 35
- ECO heating limits 31
- Economy button 90
- Electronics 103
- Engineering 100
- ERROR 28
- Error handling 19
- Error messages 28
- Evaporation temp. of heat conducting medium 87

F

- Faults 28
- Features 9
- Fields of use 11
- Flow temperature 20
- Flue gas condensation 51
- Flush-panel mounting 99
- Forced charging 63
- Forced signal 49
- Frost protection for d.h.w. 56
- Frost protection for the boiler 48
- Frost protection for the building 23

Frost protection for the collector	84
Frost protection for the plant.....	75
Frost protection function solar	84
Frost protection, plant	75
Function block	
actuator heating circuit	42
boiler	45
d.h.w.	56
district heat	54
end-user d.h.w.	25
end-user general	27
end-user space heating.....	23
legionella function.....	69
locking functions	89
multifunctional relays.....	65
plant configuration	29
service functions and general settings	72
setpoint return temperature limitation.....	51
solar d.h.w.	82
space heating	30

G

Gain factor room influence.....	38
Generation of setpoint	41
Gradient collector start function	88

H

Handling	94
Heat demand	66
Heat storage capacity	30
Heating circuit functions.....	11
Heating circuit operating modes	16
Heating curve.....	38, 42
Heating limits	31
Heating program	24
Heating up brake	43
Holiday mode	16, 24
Holiday period.....	24
Holiday program.....	24
Hours run counter	72

I

Info values.....	97
Inputs for LPB	79
Installation	99
Installation Instructions	98
Integral	47
Interconnected plants	44
Interruption.....	19

K

K6.....	65
K7.....	65
Knob.....	95
Knob for readjustments QAW70	91

L

Legionella function.....	63, 69
Legionella setpoint.....	69
Legionella weekday	69
Line selection buttons.....	96
Locking functions.....	89
Locking on the software side	89
Locking signal gain	77
Locking the settings.....	89
LPB.....	79

M

Manual control	17
Manual d.h.w. charging	12, 64
Manual positioning commands	95
Master clock	79
Maximum charging time	62
Maximum limitation of boiler temperature	46
Maximum limitation of charging temp. solar	87
Maximum limitation of flow temperature.....	42
Maximum limitation of primary return temp.	54
Maximum limitation of rate of setpoint increase. ...	43
Maximum limitation of room temperature	37
Maximum limitation of storage tank temp.....	85
Mechanical design.....	103
Minimum charging temperature solar.....	83
Minimum limitation of boiler temperature	46
Minimum limitation of flow temperature.....	42
Minimum running time collector pump.....	84
Mounting location	99
Multifunctional relays.....	65

N

No priority	59
-------------------	----

O

Operating Instructions	95
Operating level	18
Operating line principle.....	96
Operating lines	98
Operating lines QAW70.....	91
Operating state	18
Operation	94
Operation of circulating pump (legionella funct.)..	70
Optimization.....	33
Optimized switching off.....	35
Optimized switching on	36
Output relays	103
Outside sensor	20
Outside temperature.....	20
Outside temperature source	80
Overheating of collector pump	87
Overlapping heating phases.....	24
Overriding of operating mode.....	76
Overrun.....	63
Overtemperature protection for the collector.....	85

P			
Parallel displacement of heating curve.....	40	Service functions	72
Parallel operation.....	59	Setpoint for common flow.....	60
Periodic pump run.....	77	Setpoint for holiday mode	23
Plant type.....	18, 29	Setpoint increase.....	43
Plant types.....	13	Setpoint return temperature limitation	51
Progression of outside temperature	30	Setpoints.....	23
Protection against boiler overtemperatures.....	49	Setting buttons	96
Protection against discharging	63	Setting levels	97
Protection against overtemperatures.....	49	Shifting priority.....	59
Protection mode.....	16	Short-circuit	19
Protective boiler startup	49	Simulation of outside temperature	73
Protective startup.....	49	Slope of maximum limitation	54
Pulse lock heating circuit control	44	Software version.....	72
Pump kick	77	Solar charging, temperature differential	83
Pump M1	20, 50	Sommertime	27
Pump overrun	63, 76	Source of time of day	79
		Storage tank recooling (solar)	86
Q		Storage tank sensor	60
QAW70 operating lines	91	Storage tank temperature.....	21
Quick setback	35	Storage tank thermostat	60
		Stored heat	30
R		Suitable actuators.....	10
Rail mounting.....	99	Suitable room units.....	10
Recooling storage tank (solar).....	86	Suitable sensors	9
Reduction of flow temperature setpoint	37	Summertime	77
Relay test.....	73	Switching differential d.h.w.	60
Release integral.....	47		
Release of d.h.w. heating	57	T	
Reset integral.....	47	Technical data	104
Return temperature.....	21	Temperature boost mixing valve/heat exchanger	44
Room influence	38	Temperature differential solar.....	83
Room model	19, 34	Test relays	73
Room model temperature	34	Test sensors	74
Room sensor	19	Time of day (legionella function)	69
Room temperature.....	19	Type of actuator.....	43
Room temperature deviation	38	Type summary.....	9
Room temperature setpoint boost	36	Types of heating systems.....	11
Room temperature source.....	32	Types of houses and buildings.....	11
Room unit QAA50.110/101	90		
Room unit QAW70.....	91	U	
		Uncritical locking signals	77
S			
Safety functions	46	W	
Scheduler program 2	27	Wall mounting.....	99
Sealing.....	103	Winter-/summertime changeover	77
Selecting the plant type	29	Wintertime.....	27, 77
Sensor test.....	74	Wiring	98

Siemens Switzerland Ltd
Industry Sector
Building Technologies Division
Theilerstrasse 1a
CH 6300 Zug
Tel. +41 58 724 24 24
www.siemens.com/sbt

© 2011 Siemens Switzerland Ltd
Subject to change