



Climatix™
Climatix controllers POL42X.70/STD

For controlling, switching and monitoring functions

The Climatix 42X.70/STD controllers are optimized with Inbuilt HMI for air handling units, rooftop units, chillers and heat pumps, available for display, unit configuration and operation.

Controller types



POL421.70/STD



POL422.70/STD

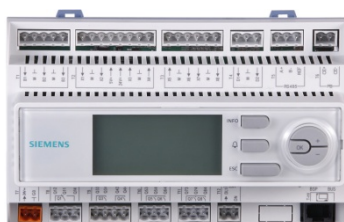

POL424.70/STD

Main features

The Climatix 42X.70/STD controllers provide the following main features:

- 6 predefined keys and organizable icons for ease of operation
- User-friendly segmented FSTN LCD interface with blue backlight
- 5-digit character display
- Specialized icons for HVAC plant
- Programmable attributes of icons via Climatix tools
- Grouped parameter for convenient index
- Power supply AC 24 V or DC 24 V
- DC 24 V and DC 5 V on-board power supplies for active sensors
- 3 analog inputs specific for temperature sensor
- 2 configurable inputs as digital input / DC 0...10 V input / temperature sensor
- 3 configurable outputs as DC 0...10 V analog output / digital output for off-board load
- 4 digital inputs specific for potential-free contacts
- 1 digital input for potential-free contact / fan speed measurement
- 1 digital input galvanic isolated (AC 115...230 V)
- 5 relay outputs (4 NO contacts, 1 changeover switching type)
- 2 triac outputs (AC 24 V / 115 V / 230 V) or 2 relay outputs (NO contacts)
- 1 stepper motor drive for electronic expansion valve or PWM output ^{1) 2)}
- On-board Modbus RTU over RS485 for Third-party bus communication
- Process bus for network functionalities (based on KNX protocol) ^{2) 3)}
- Local service connector for user interface and PC tools (supporting USB)
- SD card interface for application and operating system upgrade
- Operating temperature range is -20...60 °C
- Powerful service tools are available to facilitate commissioning

¹⁾ Available for POL421.70/STD

²⁾ Available for POL422.70/STD

³⁾ Available for POL424.70/STD

Note:

The POL42X.70/STD are standard controllers with programmability.

Communication concept

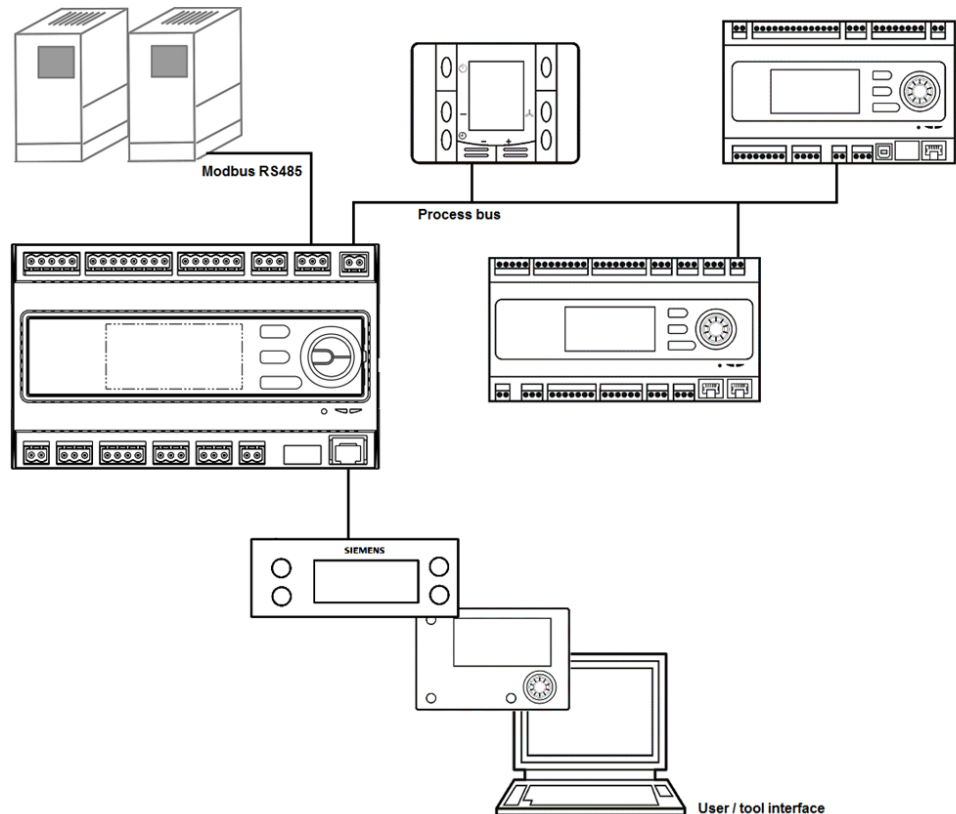

A6V10421228/1

Overview (POL 421.70/STD)

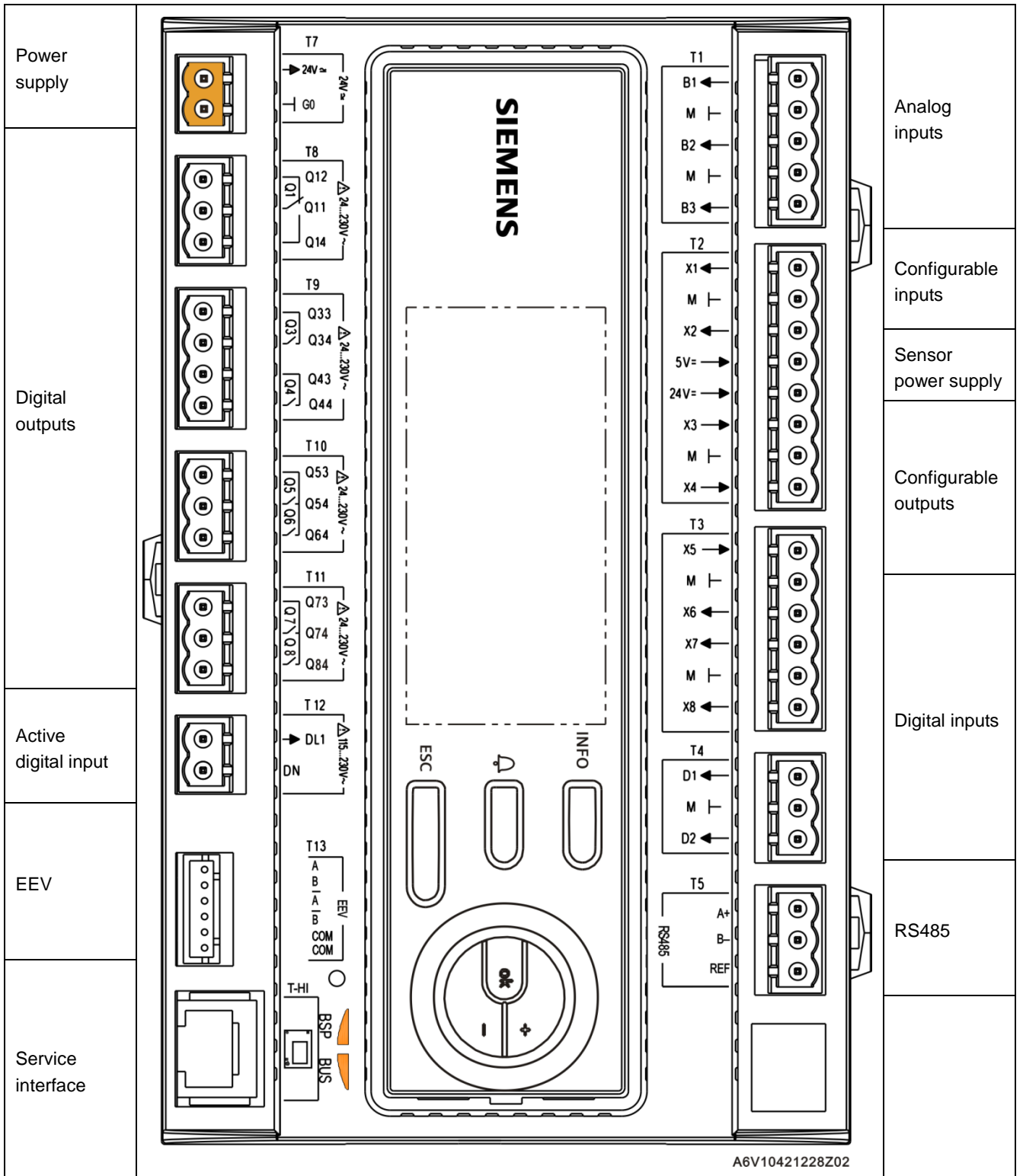

Overview (POL 422.70/STD)

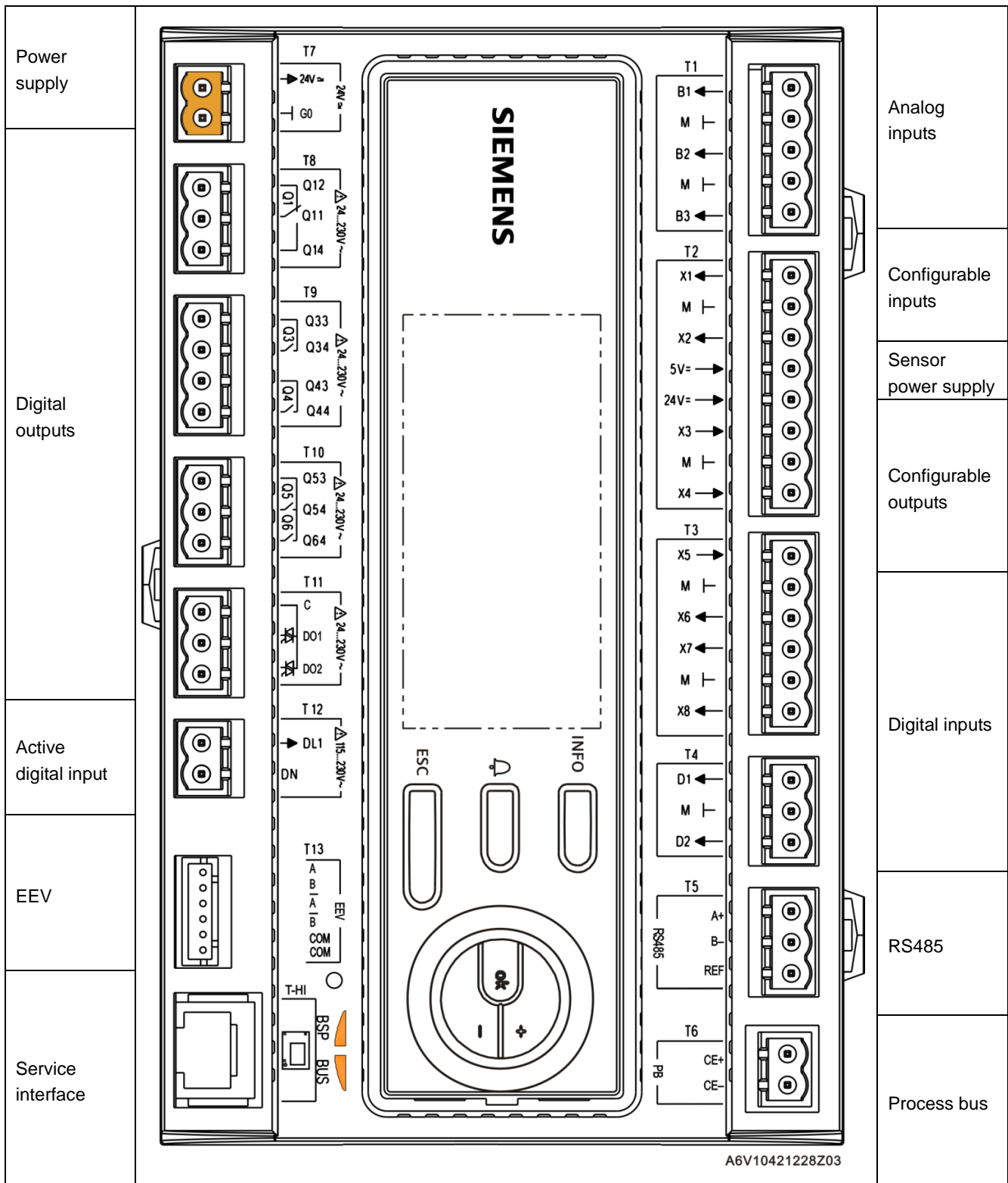

Overview (POL 424.70/STD)

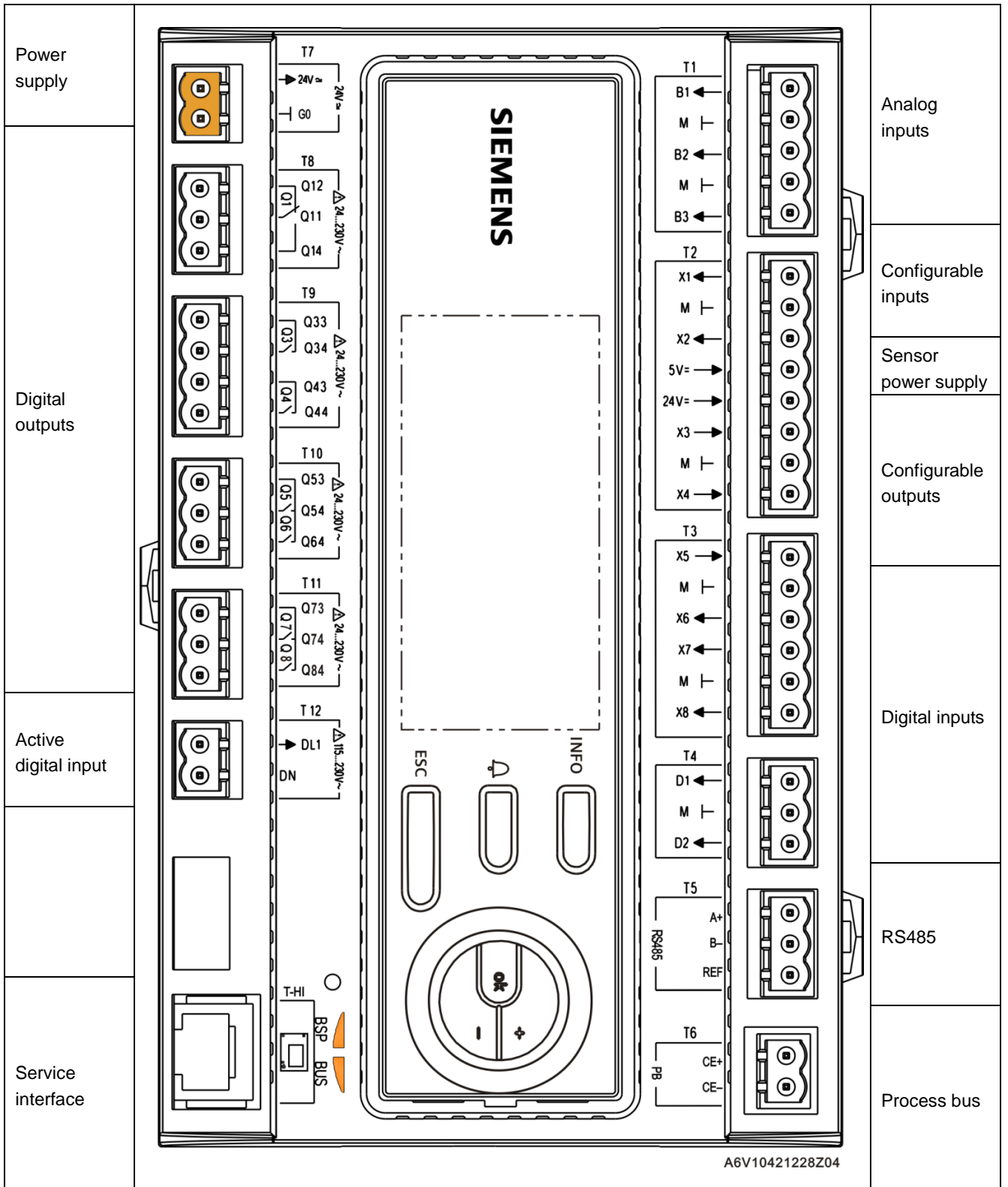

Application

LCD Display

The FSTN LCD display is subdivided into several logical blocks, containing symbols and characters associated with specific operating states to provide real time information.

All icons can be programmed with the following status via SCOPE and SAPRO (regardless of whether the application controls the Inbuilt HMI):

- Fixed display
- Flashing (interval: 500 ms)
- Non display

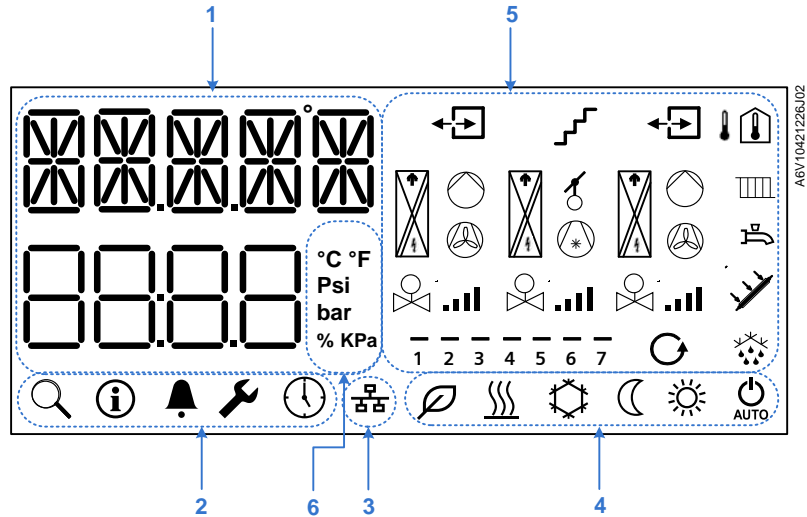

Segment introduction

No.	Designation
1	Character segment – text composed of characters
2	Menu segment – main configuration menu
3	Communication segment – flashing icon indicates a bus problem occurred between Inbuilt HMI and controller
4	Mode segment – displayed icon indicates the mode is operating
5	Device segment – displayed icon indicates the device is working
6	Engineering unit segment – displayed icon indicates the unit of a value

Icon introduction

Icon	Explanation	Icon	Explanation
Engeneering unit segment		Device segment	
°C	Degrees Celsius		Supply
°F	Degrees Fahrenheit		Exhaust
K	Kelvin		Fan
Psi, bar	Pressure in Psi or bar		Pump
Pa	Pressure in Pascal		Compressor
KPa	Presure in kPascal		Radiator
Menu segment			Domestic hot water
	Data		Solar
	Plant information		Damper
	Alarm		Valve
	Maintenance		Capacity
	Time setting		Heating coil
	Loop setting		Cooling coil
	Stage setting		Electric-heating coil
	Defrost		Heat recovery
	Energy saving		Outdoor temperature
Mode segment			Indoor temperature
	Comfort		Time scheduler / weekday
	Cooling		Power on / off
	Economy	Communication segment	
	Heating		Bus indicator
AUTO	Auto		

Character unit segment

The character unit segment is formatted and styled as follows:

First line		- Max. 5 characters *) - Left aligned
Second line		- Max. 4 numbers

*) If more than 5 characters display on the first line, the entire line of characters scrolls forward.

- In menu page of Information, max. 20 characters scroll forward.
- In menu page of Alarm, max.10 characters scroll forward.

The numbers are displayed on both lines as follows:

Numbers on the first line		1	2	3	4	5	6	7	8	9
Numbers on the second line	0	1	2	3	4	5	6	7	8	9
Numbers represented	0	1	2	3	4	5	6	7	8	9

The special symbols are displayed on the first line as follows:

Special symbols on the first line	+	-	*	.	_	\	/
Numeral represented	+	-	*	.	_	\	/

Latin letters

The Latin letters are displayed on the first line as follows:

Uppercase letter on the first line	Uppercase letter represented	Lowercase letter on the first line	Lowercase letter represented
A	A	a	a
B	B	b	b
C	C	c	c
D	D	d	d
E	E	e	e
F	F	f	f
G	G	g	g
H	H	h	h
I	I	i	i
J	J	j	j
K	K	k	k
L	L	l	l
M	M	m	m
N	N	n	n
O	O	o	o
P	P	p	p
Q	Q	q	q
R	R	r	r
S	S	s	s
T	T	t	t
U	U	u	u
V	V	v	v
W	W	w	w
X	X	x	x
Y	Y	y	y
Z	Z	z	z

















Cyrillic letters

The Cyrillic letters are displayed on the first line as follows:

Cyrillic letter on the first line	Uppercase letter represented	Lowercase letter represented
А	А	а
Б	Б	б
В	В	в
Г	Г	г
Д	Д	д
Е	Е	е
	Ё	ё
Ж	Ж	ж
З	З	з
И	И	и
	Й	й
К	К	к
Л	Л	л
М	М	м
Н	Н	н
О	О	о
П	П	п
Р	Р	р
С	С	с
Т	Т	т
У	У	у
Ф	Ф	ф
Х	Х	х
Ц	Ц	ц
Ч	Ч	ч
Ш	Ш	ш
Щ	Щ	щ
Ъ	Ъ	ъ
Ы	Ы	ы
Ь	Ь	ь
Ю	Ю	ю
Я	Я	я
Э	Э	э

Operating mode

The following running modes are customized as operating modes for easy of selection.

Operating mode	Value	Combination icons
Comfort Heat	1	 
Comfort Cool	2	 
PreComfort Heat	3	
PreComfort Cool	4	
Economy Heat	5	 
Economy Cool	6	 
Heat Pump	7	 
Economy Heat Pump	8	  
AUTO ¹⁾	15	AUTO
Standby	0	

¹⁾ Other combination icons can be displayed together with AUTO according to the real running mode.

Disposal



The devices are considered electronics devices for disposal in terms of European Directive 2012/19/EU and may not be disposed of as domestic waste.

- Dispose of the device via the channels provided for this purpose.
- Comply with all local and currently applicable laws and regulations.

Technical data

Power supply

AC 24 V, G0 (T7)

Operating voltage	AC 24 V $\pm 20\%$ / DC 24 V $\pm 10\%$
Frequency	45...65 Hz at AC 24 V
Max. AC current	1.6 A at AC 24 V (POL421.70, POL422.70) 1.1 A at AC 24 V (POL424.70)
Max. DC current	1.5 A at DC 24 V (POL421.70, POL422.70) 1.0 A at DC 24 V (POL424.70)
Max. external supply line fusing	6.3 A slow wire fuse or circuit breaker

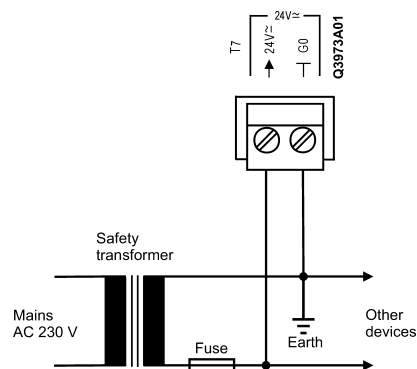

Relay output

Q1 (T8)

Relay

Contact	Monostable, NO / NC contact, SPDT
Switching voltage	AC 24...230 V (-20%, +10%) DC 18...30 V
Rated current (res. / ind.)	AC 3 A (res.) / 2 A (ind. $\cos\phi$ 0.6) DC 3 A (res.)
Min. switching current at AC 19 V	30 mA
Endurance	100,000 cycles at AC 230 V, 3.0 A (res.)
Max. external supply line fusing	6.3 A slow wire fuse or circuit breaker



Do not mix SELV / PELV and line voltage on the same terminal.

Use external protection for inductive load.

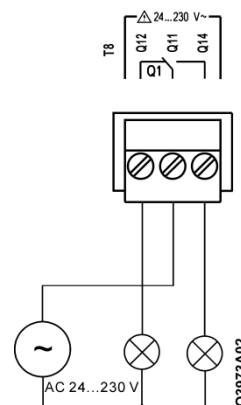

Relay outputs

Q3, Q4 (T9)

Q5, Q6 (T10)

Relay

Contact

Monostable, NO contact, SPST

Switching voltage

AC 24...230 V (-20%, +10%)

DC 18...30 V

Rated current (res. / ind.)

AC 3 A (res.) / 2 A (ind. $\cos\phi$ 0.6)

DC 3 A (res.)

Min. switching current at AC 19 V

30 mA

Endurance

100,000 cycles at AC 230 V, 3.0 A (res.)

Max. external supply line fusing

6.3 A slow wire fuse or circuit breaker



Do **not** mix SELV / PELV and line voltage on the same terminal.

Use external protection for inductive load.

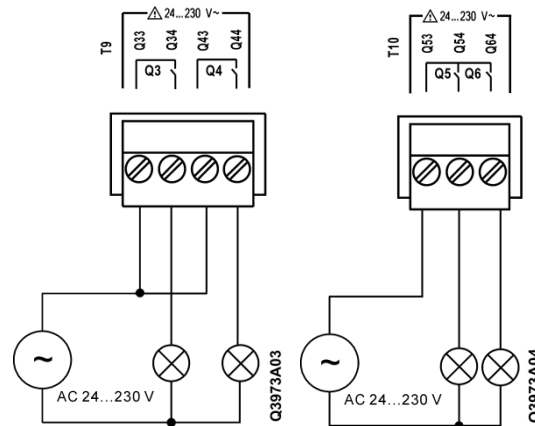

Relay outputs

Q7, Q8 (T11)

Relay

Contact

(Assembled in POL421.70, POL424.70)

Switching voltage

Monostable, NO / NC contact, SPST

AC 24...230 V (-20%, +10%)

DC 18...30 V

Rated current (res. / ind.)

AC 3 A (res.) / 2 A (ind. $\cos\phi$ 0.6)

DC 3 A (res.)

Min. switching current at AC 19 V

30 mA

Endurance

100,000 cycles at AC 230 V, 3.0 A (res.)

Max. external supply line fusing

6.3 A slow wire fuse or circuit breaker



Do **not** mix SELV / PELV and line voltage on the same terminal.

Use external protection for inductive load.

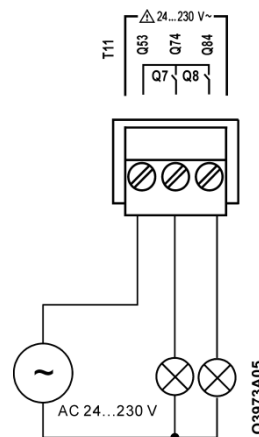

Triac outputs
DO1, DO2 (T11)

Triac data	(Assembled in POL422.70)
Switching voltage	AC 24...230 V (-20%, +10%)
Switching capacity	Max. 500 mA Min. 30 mA ¹⁾
Max. external supply line fusing	2.0 A slow wire fuse or circuit breaker
¹⁾ The minimum value depends on environment temperature.	



Do not mix SELV / PELV and line voltage on the same terminal.

Use external protection for inductive load.

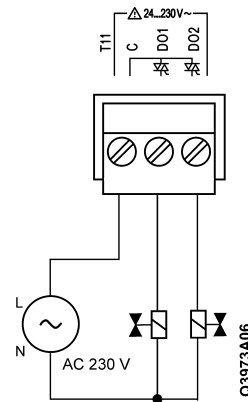

Analog inputs
B1...B3 (T1)

NTC 10k ($B_{25/85}=3977$ K)	(Assembled in POL421.70, POL422.70)	
Sensor current	120 μ A at 25 °C	
Temperature range	-50...100 °C	
Accuracy and resolution of input Temperature	See diagram below	
	Accuracy	Resolution
-50 °C	2.5 K	0.6 K
-40 °C	1.4 K	0.4 K
-30 °C	0.9 K	0.2 K
-10 °C	0.5 K	0.1 K
50 °C	0.7 K	0.2 K
70 °C	1.3 K	0.4 K
90 °C	2.5 K	0.7 K
100 °C	3.4 K	0.9 K

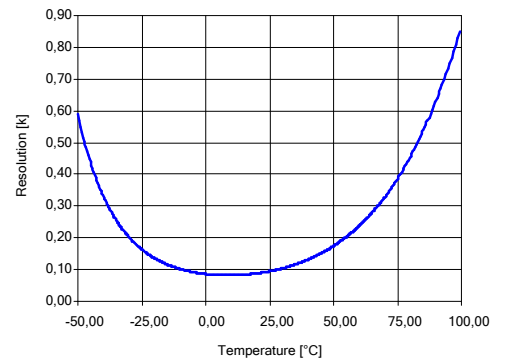
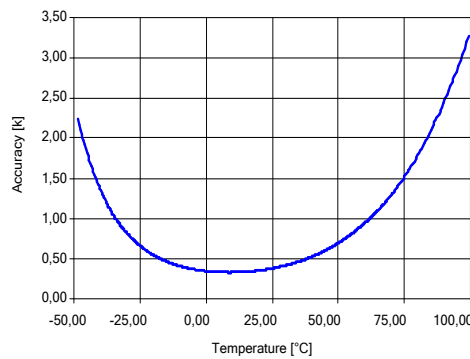

LG-Ni1000 (TK5000) / Pt1000

Sensor current
 Temperature range
 Accuracy
 Resolution

(Assembled in POL424.70)

1.4 mA at 0 °C
 -48...150 °C
 ±1 K
 ±0.25 K

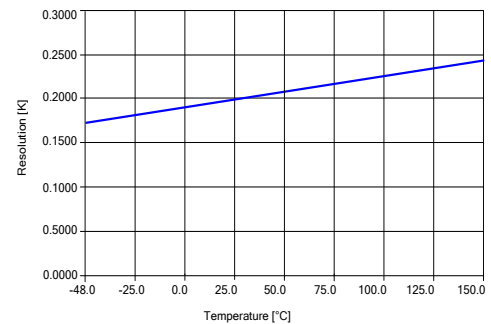
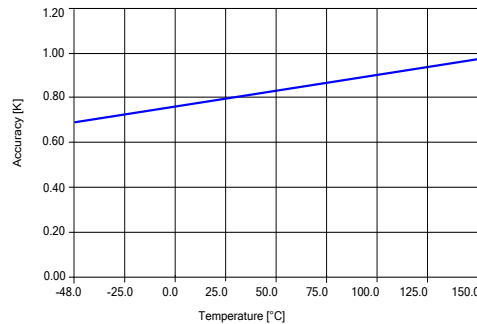

These data are acquired under operating temperature of 25 °C.

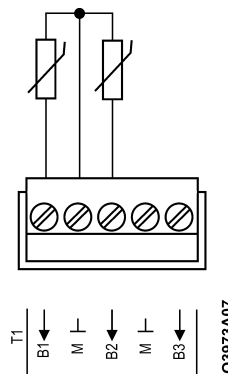

Configurable inputs

X1, X2 (T2)

Configurable
 Reference potential

By software
 Terminals ⊥

NTC 10k ($B_{25/85}=3977$ K)
 Accuracy

(Assembled in POL421.70, POL422.70)
 Please refer to B1...B3

LG-Ni1000 (TK5000)
 Accuracy

(Assembled in POL424.70)
 Please refer to B1...B3

DC 0...5 / 0...10 V ratiometric sensor

Resolution
 Accuracy
 Input resistance

50 mV
 100 mV
 100 kΩ

Digital input

0/1 digital signal (binary)
 Sampling voltage / current
 Contact resistance

For potential-free contacts
 DC 24 V, 8 mA
 Max. 200 Ω (closed)
 Min. 50 kΩ (open)

Delay
 Pulse frequency

10 ms
 Max. 20 Hz



Avoid negative voltages at the analog inputs because the conversion leads to indetermined results.

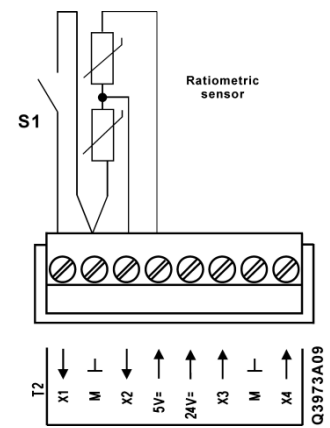
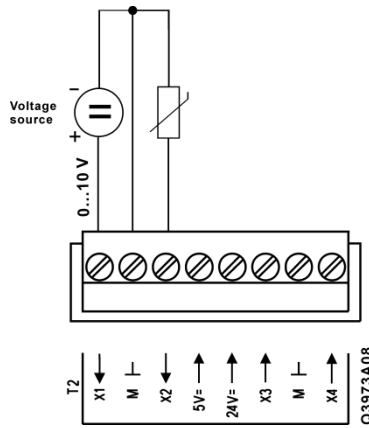

Configurable outputs
X3, X4 (T2), X5 (T3)

Configurable
Reference potential

By software
Terminals ⊥

DC 0...10 V output

Resolution 30 mV
Accuracy 100 mV
Output current Max. 1 mA

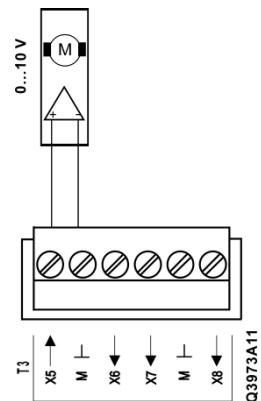
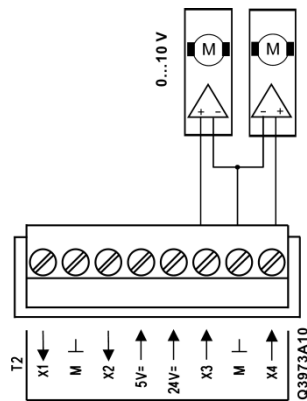

DC output for off-board load

Switching voltage DC 24 V
Switching capacity Max. 25 mA

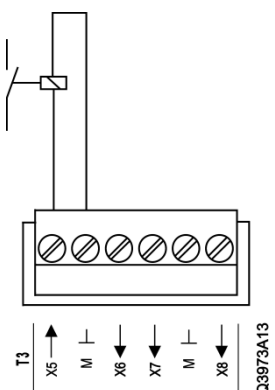
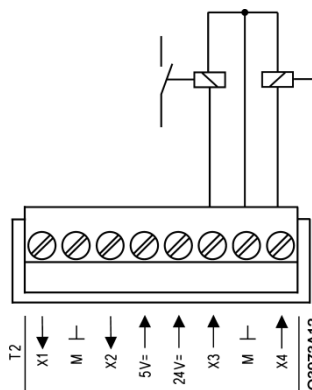

Note:

Use free wheel diode for inductive load.

Digital inputs

X6, X7 (T3)

DI1, DI2 (T4)

0/1 digital signal (binary)
 Sampling voltage / current
 Contact resistance

For potential-free contacts

DC 24 V, 8 mA

Max. 200 Ω (closed)

Min. 50 kΩ (open)

Delay

10 ms

Pulse frequency

Max. 20 Hz

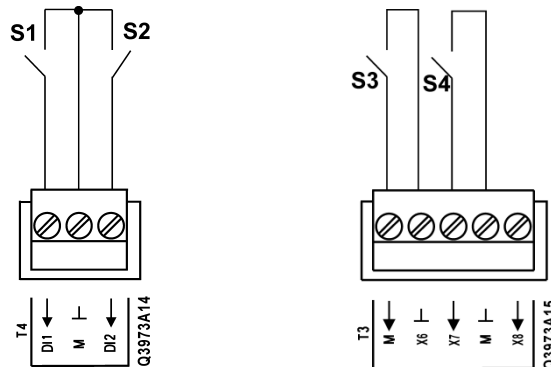
**Digital input**

X8 (T3)

Configurable

By software

0/1 digital signal (binary)

Sampling voltage / current

For potential-free contacts

DC 24 V, 8 mA

Contact resistance

Max. 200 Ω (closed)

Min. 50 kΩ (open)

Delay

10 ms

Pulse frequency

Max. 20 Hz

Pulse measurement

Sensor

Open-collector

Sampling voltage

DC 24 V, Max. 8 mA

Max. speed

6000 RPM

Min. ON / OFF time

500 μs

Powering supply for sensors

Active / ratiometric

DC 5 V, DC 24 V (T2)

Voltage / current

DC 5 V ±2.5%, 20 mA

Voltage / current

DC 24 V (-25%, +10%), 40 mA

Reference potential

Terminals ⊥

Connection

Short-circuit protected

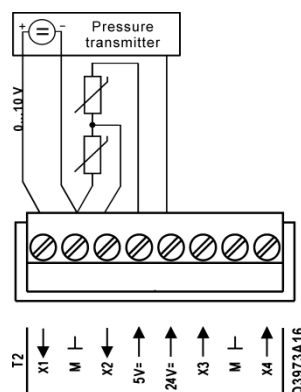

Active digital input
DL1 (T12)

Digital input (0/1 binary)

Nominal voltage
Frequency range
Input current
Delay
Pulse frequency

Galvanic isolated voltage input
AC 115...230 V (-15%, +10%)
45...65 Hz
3 mA at AC 230 V
100 ms
Max. 5 Hz

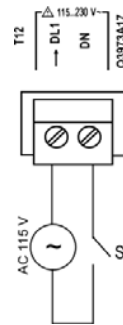

EEV (T13)

Configurable
Connector

By software
B6B-XH-A, JST

Stepper motor drive

Motor

Connection
Supply voltage
Driver output

(Assembled in POL421.70, POL422.70)
Unipolar stepper motor
DC 12 V, Max. 2 x 375 mA
5/6 wires
DC 12 V (short-circuit protected)
4 channels

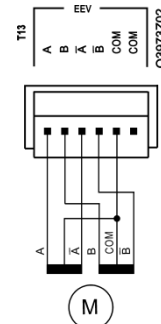
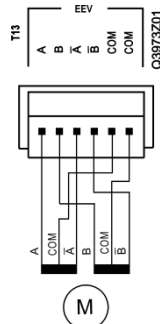

Note:

Maximum current for phase A and phase B is 375 mA respectively.

PWM output

Frequency
Duty cycle
Max. current
Supply voltage on COM

(Assembled in POL421.70, POL422.70)
1...60 Hz
0...100% (at increments of 0.5%)
750 mA (short-circuit protected)
12 V, Max. 750 mA (short-circuit protected)

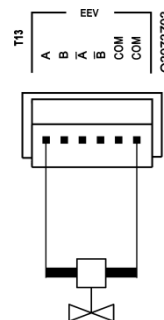

Note:

Only channel A supports PWM output.

Interfaces

Process bus
CE+, CE- (T6)

Based on KNX TP1

Bus connection
 Bus electronics
 Bus load
 Bus cable

 Bus cable length between 2 nodes
 Total length of bus cable
 DPSU

(Assembled in POL422.70, POL424.70)
 CE+, CE-, not interchangeable
 Galvanic isolated
 Max. 5 mA
 Must be shielded; Please refer to
KNX manual - System Specifications
 Max. 350 m
 Max. 700 m
 40 mA rated current

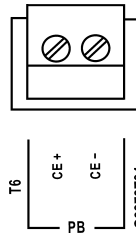

Third-party bus
(RS-485 Modbus RTU
or BACnet MSTP)
 A+, B-, REF (T5)

RS485 (EIA-485)

Bus connection
 Bus protocols
 Bus electronics
 Bus cable
 Bus polarization
 Baud rate
 Bus termination

1 interface on terminal T5
 A+, B-, REF
 Modbus RTU mode or BACnet MSTP
Not galvanic isolated
 Shielded twisted pair (like AWG 24)
 Switchable by software (680 Ω)
 600, 1200, 2400, 4800, 9600, 19200, 38400
 None (require external termination, e.g. 150 Ω)*

Note:

*It is essential to use a network termination on each end of the RS485 network, which matches the cable's impedance to prevent signal reflections and corrupting the data on RS485 network.

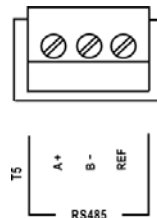

Tools / HMI
Local service interface
 (T-HI)

Cable connection

RJ45 jack, 8 pins, length of cable < 3 m

Local-HMI

RS-485 (EIA-485)
 Bus polarization
 Bus termination
 Supply voltage

Not galvanic isolated
 680 Ω / 680 Ω
 120 Ω / 1 nF
 DC 24 V, Max. 100 mA
 (short-circuit protected)

Tool

USB

Use PC service cable POL0C2 for tools

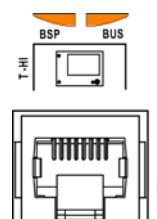

LED for BSP run / stop	Mode	LED status
	SW update mode (download active on a new BSP, application) Application running Application loaded but not running Application not loaded BSP error (software error) Hardware error	Alternating between red and green every second Green on Yellow on Yellow on Red flashing at 2 Hz Red on
Note:	LED for bus is <u>not</u> in operation.	
Connection terminals	Possible plugs for I/O signals and communication (available on request)	Phoenix FKCVW 2,5/x-ST Phoenix FKCT 2,5/x-ST Phoenix MVSTBW 2,5/x-ST
	Possible plugs for power supply (available on request)	Phoenix FKCVW 2,5/2-ST OG Phoenix FKCT 2,5/2-ST OG Phoenix MVSTBW 2,5/2-ST OG
	Solid wire	0.5...2.5 mm ²
	Stranded wire (twisted or with ferrule)	0.5...1.5 mm ²
Real-time clock	Buffering with internal Gold Cap	Min. 4 hours
 SD card	SD card	At the right side of the housing
	Max. capability Format	32 GB FAT32 Note: New SD card must be formatted with FAT32 standard before use.
Environment	Operation	IEC 60721-3-3
	Temperature	-20...60 °C
	Humidity	< 90% r.h. (non-condensing)
	Air pressure	Min. 700 hPa, corresponding to Max. 3,000 m above sea level
	Transport	IEC 60721-3-2
	Temperature	-40...70 °C
Humidity	< 95% r.h. (non-condensing)	
Air pressure	Min. 260 hPa, corresponding to Max. 10,000 m above sea level	
Mechanical conditions	IEC 60721-3-2 Class 2M2	
Protection	Degree of protection	IP20 (EN 60529)
	Safety class	Suitable for use in plants with safety class II

Standards	EU Conformity (CE) Listings	800080034_xx *) UL916, UL873 CSA C22.2M205
	RCM conformity	8000080035 *)
	<hr/>	
Environmental compatibility	The product environmental declaration A5Q00058873H-01-78 contains data on environmentally compatible product design and assessments (RoHS compliance, materials composition, packaging, environmental benefit, disposal).	
General data	Dimensions	See "Dimensions"
	Weight excl. packaging	469 g
	Base	Plastic, pigeon blue RAL 5014
	Housing	Plastic, light grey RAL 7035
Accessories (available on request)	PC service cable 1.5 m	POL0C2.40/STD
	<hr/>	
	Connector set (screw, cable side entry)	POL042.25/STD
	1 x Phoenix MVSTBW 2,5/2-ST OG	
	2 x Phoenix MVSTBW 2,5/2-ST GY7035	
	7 x Phoenix MVSTBW 2,5/3-ST GY7035	
	1 x Phoenix MVSTBW 2,5/4-ST GY7035	
	1 x Phoenix MVSTBW 2,5/5-ST GY7035	
	1 x Phoenix MVSTBW 2,5/8-ST GY7035	
	<hr/>	

*) The documents can be downloaded from <http://siemens.com/bt/download>.

Climatix POL42X.70 variants list

Hardware I/Os		POL421.70/STD	POL422.70/STD	POL424.70/STD
Analog inputs	B1, B2, B3 (NTC 10k)	✓	✓	
	B1, B2, B3 (LG-Ni1000 / Pt1000)			✓
Configurable inputs	X1, X2 (NTC 10k / DC 0...10 V / DI)	✓	✓	
	X1, X2 (LG-Ni1000 / DC 0...10 V / DI)			✓
Digital inputs	X6, X7 (binary)	✓	✓	✓
	X8 (binary / fan speed)	✓	✓	✓
	D1, D2 (binary)	✓	✓	✓
	DL1 (active AC 115...230 V)	✓	✓	✓
Configurable outputs	X3, X4, X5 (DC 0...10 V analog output / offboard digital output)	✓	✓	✓
Digital outputs	Q1, Q3, Q4, Q5, Q6 (relay output)	✓	✓	✓
	Q7, Q8 (relay output)	✓		✓
	DO1, DO2 (triac output)		✓	
Interfaces	Process bus interface		✓	✓
	Modbus RTU or BACnet MSTP interface	✓	✓	✓
	EEV (stepper motor drive / PWM)	✓	✓	
	SD card interface	✓	✓	✓

Mounting instructions

- The product is used for flush panel mounting with a front mounting kit.
- Do not mount the product in recesses, shelving, behind curtains or doors or above or near direct heat sources.
- Avoid exposure to direct sunlight and draught.
- Seal the conduit on the device side, as currents of air in the conduit can affect the sensor reading.
- Observe the admissible ambient conditions.

Ordering

Please specify the quantity, product name, ASN and SSN when ordering. The following information is an example:

Minimum Order Quantity	Product name	ASN (product no.)	SSN (stock no.)
18	Climatix 400 controller with Inbuilt HMI	POL421.70/STD	S55394-C217-A100
18	Climatix 400 controller with Inbuilt HMI	POL422.70/STD	S55394-C227-A100
18	Climatix 400 controller with Inbuilt HMI	POL424.70/STD	S55394-C247-A100



In order to protect against accidental contact with relay connections at voltages above $42 V_{\text{eff}}$, the device must be installed in an enclosure (preferably a control panel). It must be impossible to open the enclosure without the aid of a key or tool. AC 230 V cables must be double-insulated against safety extra-low voltage (SELV) cables.

Do **not** mix SELV / PELV and line voltage on the same terminal.

Use external protection for inductive load of relay outputs.

Use external fuse for over current protection of relay and triac outputs.

Avoid negative voltage on analog inputs, because the measured ADC values are undefined. The accuracy of the 10 V analog inputs is valid for values above 100 mV.

Dimensions (mm)

POL 421.70/STD

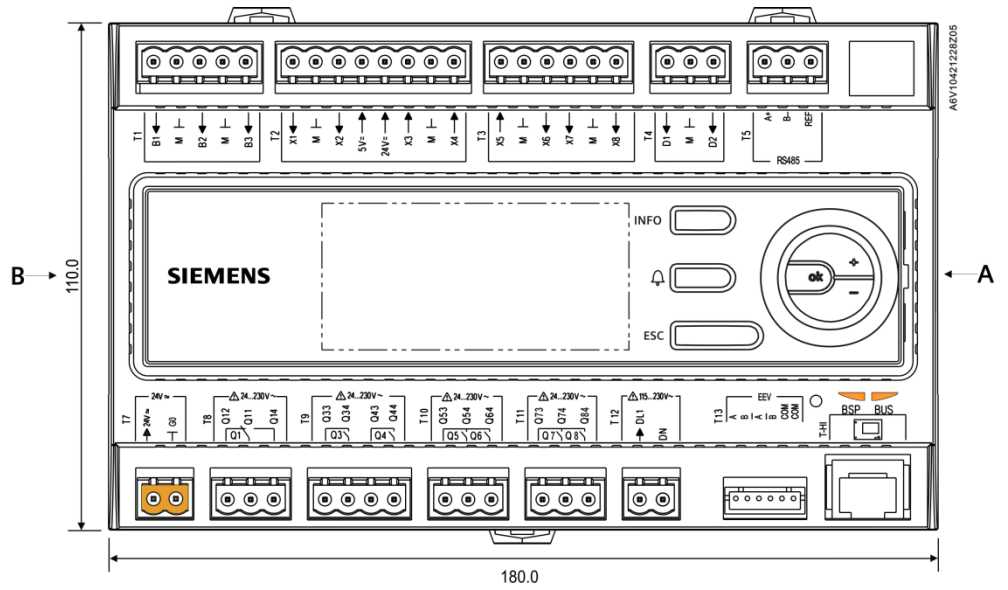

POL 422.70/STD

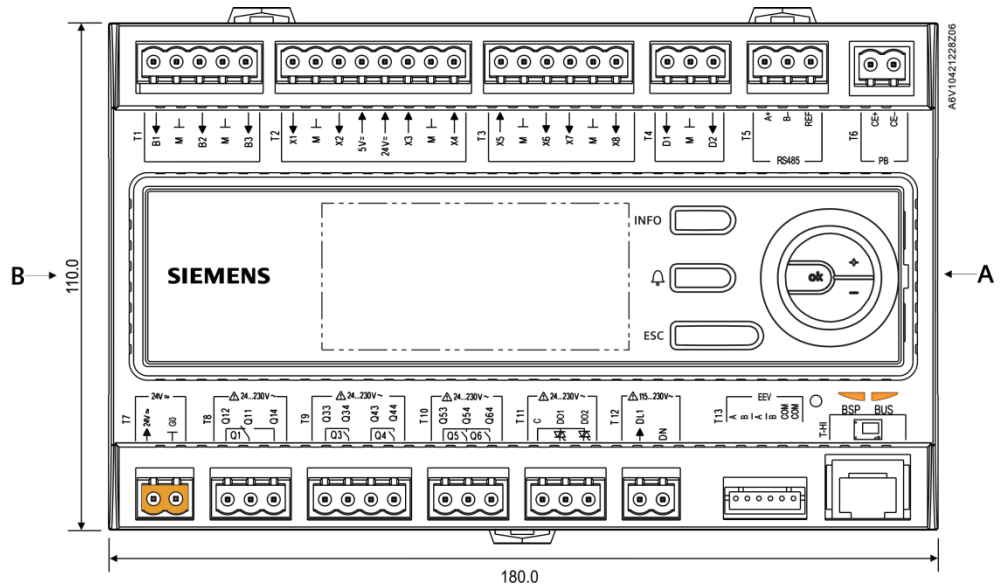

POL 424.70/STD

