



3-Port Seat Valves with Male Thread, PN 16

VXG48...

- Cast iron EN-GJL-250 valve body
- DN 20...DN 40
- k_{vs} 6.3...20 m³/h
- Flat sealing connections with external thread G...B to ISO 228/1
- Sets of ALG...3 screwed fittings with threaded connection available from Siemens
- Manual adjustment by means of mounted knob
- Can be equipped with SSY319... and SSC...motoric actuators

Use

- For use as a tight-sealing control and changeover valve in small heating, ventilation and air conditioning systems for mixing and diverting functions.
- Used in closed-circuit zone heating systems, e.g. for apartments, individual rooms or individual floors in a building.

Media

Cooling water Chilled water Low temperature hot water Water with anti-freeze	1...120 °C
---	------------

Type summary

Type reference	DN	k_{vs} [m ³ /h]	S_v
VXG48.20-6.3	20	6.3	> 100
VXG48.25-10	25	10	
VXG48.32-16	32	16	
VXG48.40-20	40	20	

DN = Nominal size

k_{vs} = Nominal flow rate of cold water (5...30 °C) through the fully open valve (H_{100}) by a differential pressure of 100 kPa (1 bar)

S_v = Rangeability k_{vs} / k_{vr}

k_{vr} = Smallest k_v value, at which the flow characteristic tolerances can still be maintained, by a differential pressure of 100 kPa (1 bar)

Accessories

Type reference	Description
ALG...3	Set of 3 screwed fittings for 3-port valves, consisting of <ul style="list-style-type: none"> - 3 union nuts - 3 discs and - 3 flat seals

Order

When ordering please give quantity, product name and type reference.

Example: 3 valves VXG48.25-10
3 sets of screwed fittings ALG253

Delivery

Valves, actuators and accessories are packed and supplied separately.

Equipment combinations

Valves	Actuators		Fitting sets Type reference
	Δp_{\max} mixing [kPa]	Δp_{\max} diverting ¹⁾ [kPa]	
VXG48.20-6.3	300	75	ALG203
VXG48.25-10			ALG253
VXG48.32-16	175	50	ALG323
VXG48.40-20	100	30	ALG403

¹⁾ If noise is permitted, the same values apply as for mixing

Δp_{\max} = Maximum permissible differential pressure across valve's control path, valid for the entire actuating range of the motorized valve

Actuator overview

Type reference	Operating voltage	Positioning signal	Positioning time	Data sheet
SSY319	AC 230 V	3 position	150 s	Q4899
SSC319				Q4895
SSC819	AC 24 V	DC 0...10 V	30 s	
SSC619				

Valve cross section

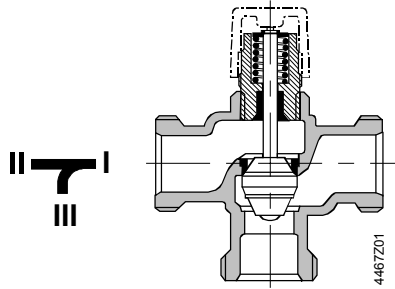

- The guided parabolic plug is attached to the valve stem.
- The seat in the through-port is embedded.
- The seat in the bypass is machined into the valve body.
- From DN 25 the seat in the through-port is machined into the valve body and the seat ring in the bypass embedded.

Sizing

Flow diagram

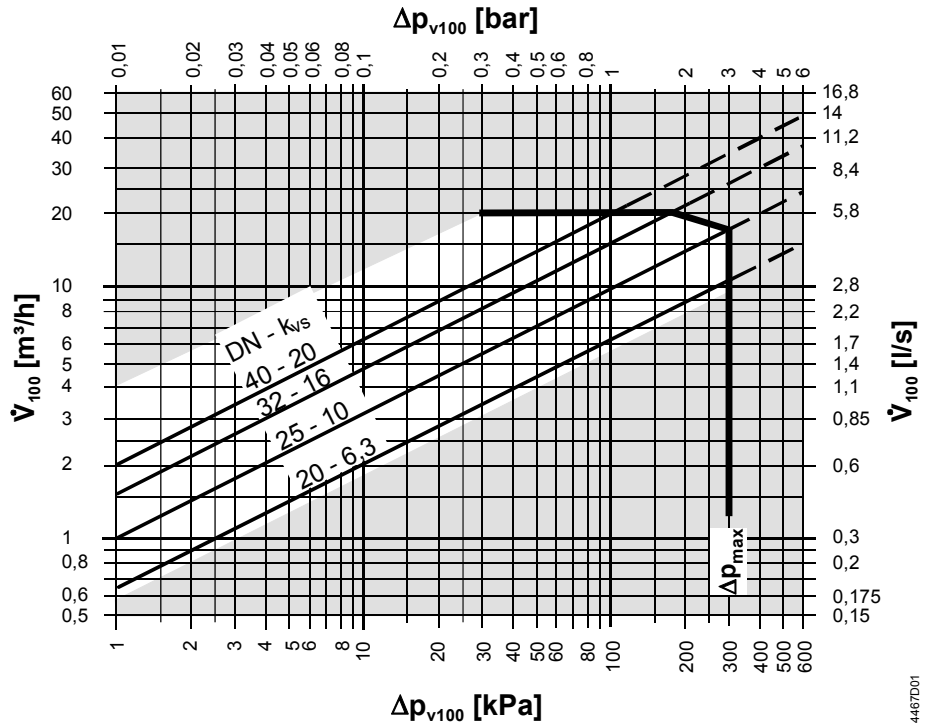

- Δp_{max} = Maximum permissible differential pressure across the valve's control path, valid for the entire actuating range of the motorised valve
- Δp_{v100} = Differential pressure across the fully open valve and the valve's control path by a volume flow V_{100}
- \dot{V}_{100} = Volume flow through the fully open valve (H_{100})
- 100 kPa = 1 bar \approx 10 mWS
- 1 m³/h = 0.278 l/s water at 20 °C

Valve flow characteristic

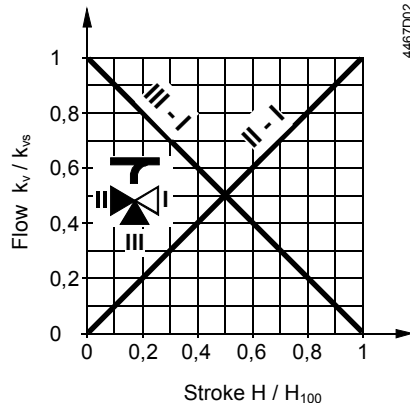

- Through-port: linear as per VDI /VDE2173
- Bypass: linear as per VDI /VDE2173

Mixing:
Flow from port II and port III to port I

Diverting:
Flow from port I to port II and port III

- Port II = variable flow
- Port III = Bypass (variable flow)
- Port I = constant flow

Use the three-port valve primarily as a mixing valve.

Notes

Engineering

Always use a strainer upstream of the valve to increase the valve's functional safety.

Mounting

Both valve and actuator can easily be assembled at the mounting location. Neither special tools nor adjustments are required.

The valve is supplied with Mounting Instructions 4 319 9597 0.

Orientation

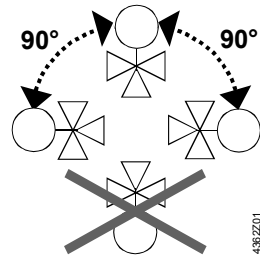

Direction of flow

When mounting, pay attention to the valve's flow direction symbol:

- Mixing from II / III to I
- Diverting from I to II / III



Commissioning



Commission the valve only if the manual knob or actuator have been mounted correctly.

Valve stem retracts: Through-port II – I opens, Bypass III closes

Valve stem extends: Through-port II – I closes, Bypass III opens

Maintenance

Warning

VXG48... valves require no maintenance.

When doing service work on the valve / actuator:

- Deactivate the pump and turn off the power supply
- Close the shutoff valves
- Fully reduce the pressure in the piping system and allow pipes to completely cool down

If necessary, disconnect the electrical wires.

Before putting the valve into operation again, make certain the actuator is correctly fitted.

Stem sealing gland

The stem sealing gland cannot be exchanged. In the case of leakage, the entire valve must be replaced. Contact your local office or branch.

Disposal

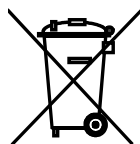

Before disposal the valve must be dismantled and separated into its various constituent materials.

Legislation may demand special handling of certain components, or it may be sensible from an ecological point of view.

Current local legislation must be observed.

Warranty

The technical data given for these applications is valid only in conjunction with the Siemens actuators as detailed under «Equipment combinations».

All terms of the warranty will be invalidated by the use of actuators from other manufacturers.

Technical data

Functional data	PN class	PN 16 to EN 1333	
	Permissible operating pressure	1600 kPa (16 bar) to ISO 7268 / EN1333	
	Working pressure	to DIN 4747 / DIN 3158 in the range of 1...120 °C	
	Flow characteristic	linear to VDI / VDE 2173 (through-port and bypass)	
	Leakage rate	0...0.05 % of k_{vs} value to DIN EN 1349 (through-port and bypass)	
	Permissible media	cooling water, chilled water, low temperature hot water, water with anti-freeze. recommendation: water treatment to VDI 2035	
	Medium temperature	1...120 °C	
	Rangeability S_v	> 100	
	Nominal stroke	5.5 mm	
	Industry standards	Pressure Equipment Directive	PED 97/23/EC
		Pressure Accessories	as per article 1, section 2.1.4
Fluid group 2		without CE-marking as per article 3, section 3 (sound engineering practice)	
Materials	Valve body	cast iron EN-GJL-250	
	Seat in through-port	DN 20	brass
		> DN 20	cast iron
	Seat in bypass	DN20	cast iron
		> DN 20	brass
	Plug	brass	
	Stem	stainless steel	
	Sealing gland	brass	
gland materials	EPDM O rings		
Dimensions / Weight	Refer to «Dimensions»		
	External thread connections	G...B to ISO 228/1	
	Actuator connection	G $\frac{3}{4}$ "	

Dimensions

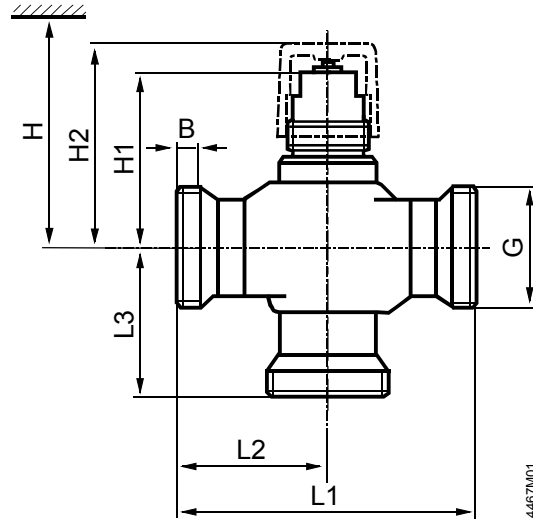

Type	DN	B [mm]	G [Zoll]	L1 [mm]	L2 [mm]	L3 [mm]	H1 [mm]	H2 [mm]	H	Weight [kg]
VXG48.20-6.3	20	10	G1¼B	100	50	50	59.5	68	> 200	0.8
VXG48.25-10	25	12	G1½B	105	52.5	52.5	62.5	71		1.2
VXG48.32-16	32		G2B				69	77.5		1.5
VXG48.40-20	40	13	G2¼B	130	65	65	72	80.5		2.2

DN = Nominal size

H = Total actuator height from pipe centre plus minimum distance to the wall or the ceiling for mounting, connection, operation, service, etc.

H1 = Dimension from the pipe centre to install the actuator

H2 = Pipe centre to upper edge of manual adjustment button, valve in «closed» position (II – I) (stem fully extended)

Screwed fittings

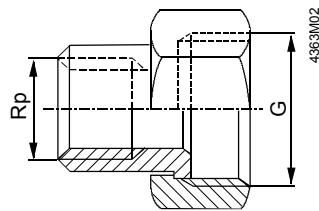

Type reference	for valve type	G [Zoll]	Rp [Zoll]
ALG20...	VXG48.20	G1¼	Rp¾
ALG25...	VXG48.25	G1½	Rp1
ALG32...	VXG48.32	G2	Rp1¼
ALG40...	VXG48.40	G2¼	Rp1½

- On valve side: cylindrical thread to ISO 228/1
- On pipe side: with cylindrical thread to ISO 7/1